

UN CIRCOLO VIRTUOSO

A VIRTUOUS CIRCLE

Dal **1964** progettiamo e sviluppiamo terminali, connettori, tecnologie e macchine per la connessione elettrica. Tutti i processi sono realizzati internamente promuovendo costantemente la loro innovazione per garantire la *qualità* dei nostri prodotti e l'accrescimento della conoscenza aziendale.

Since **1964** we design and develop terminals, connectors, connection technologies and machines for electric connections. All processes are implemented internally by a continuous innovation in order to guarantee the *quality* of our products and the growth of know-how.

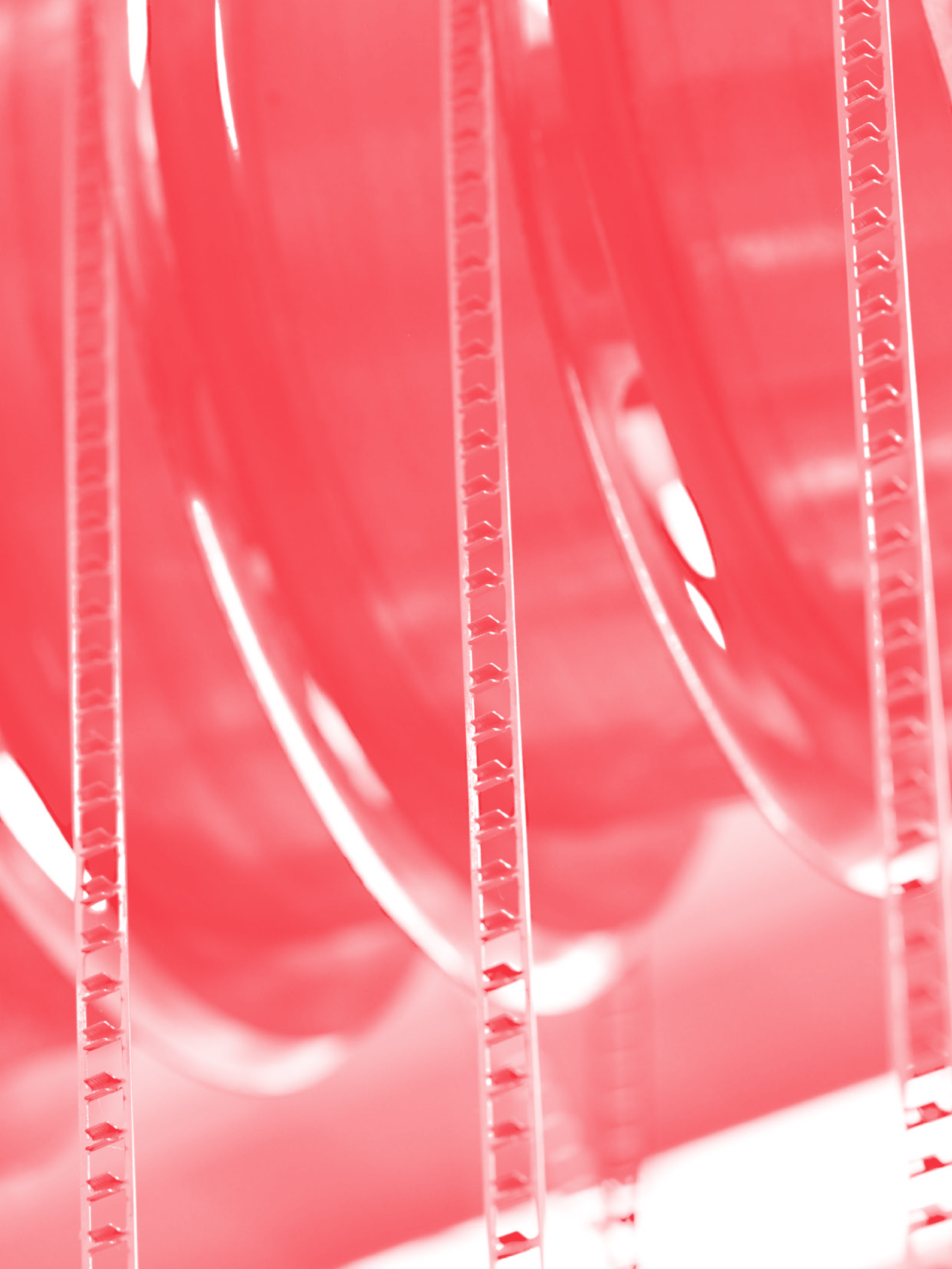

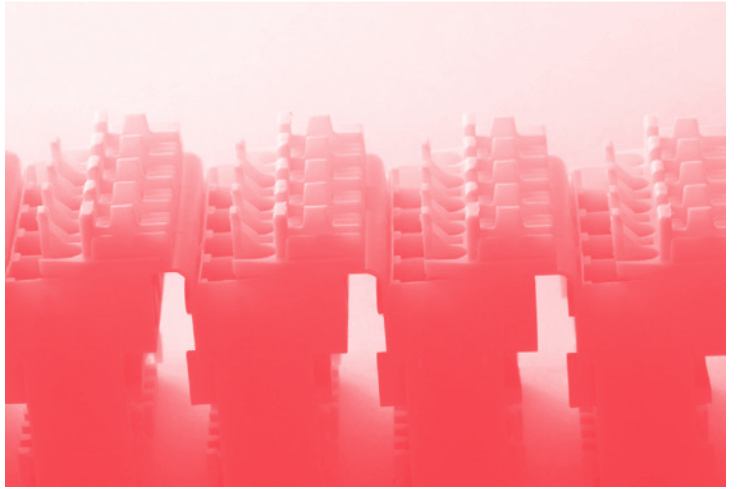
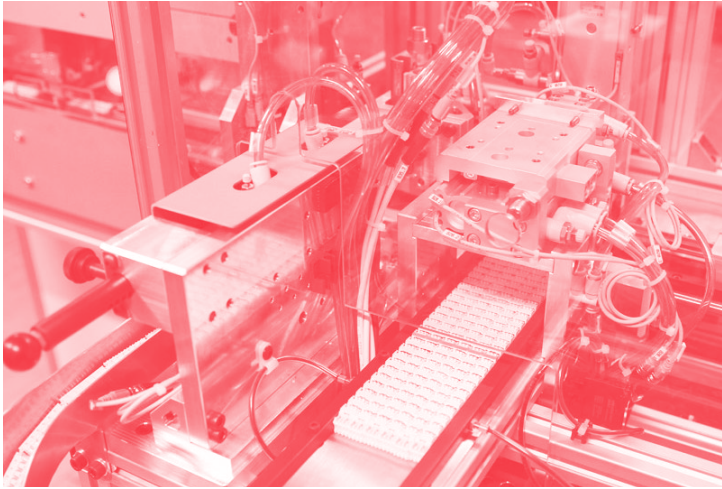

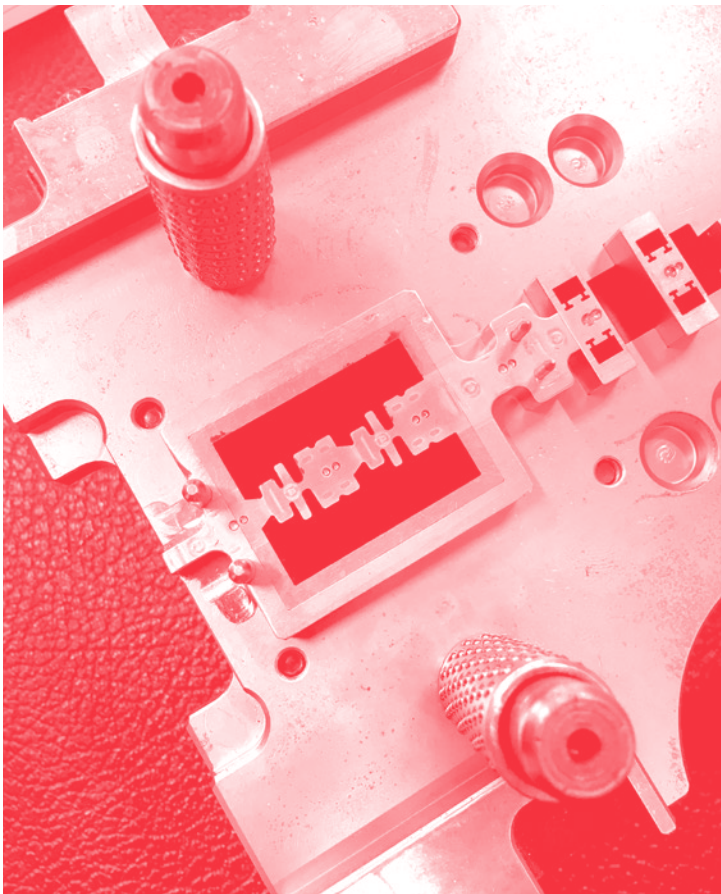
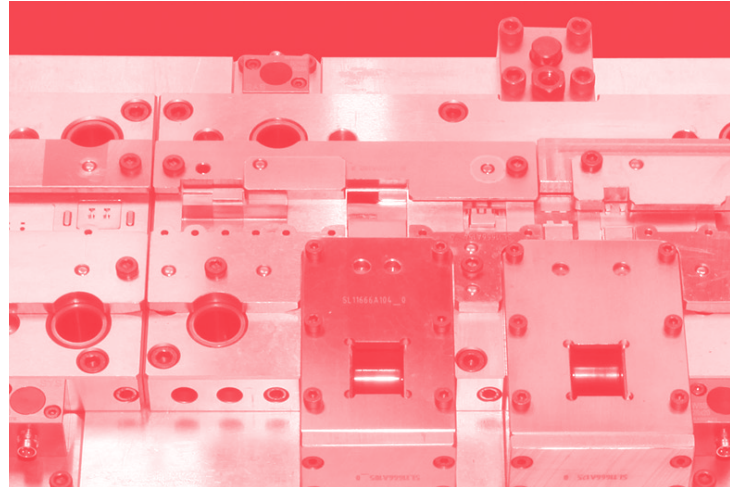

RICERCA E SVILUPPO

R&D

Il nostro impegno è sempre dedicato ad affrontare e risolvere i bisogni dei nostri clienti per proporre *soluzioni* e non semplici prodotti. Investiamo mediamente più del **10%** del nostro fatturato in nuovi prodotti e tecnologie. Crediamo nell'*innovazione*.

Our commitment is always addressed to face and solve our customers' needs in order to propose them *solutions* and not simple products. We invest on average more than **10%** of our turnover in new products and technologies. We believe in *innovation*.

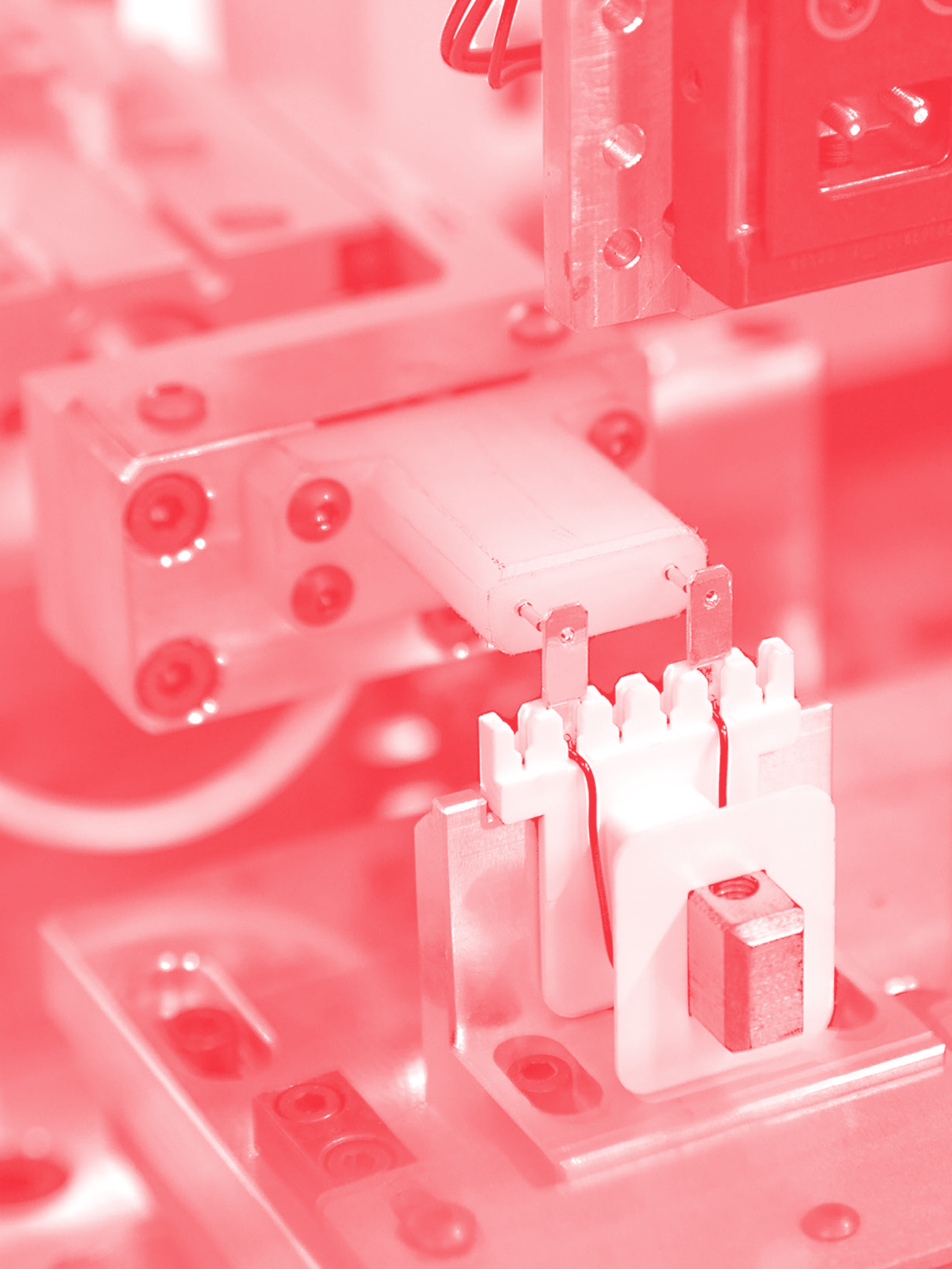

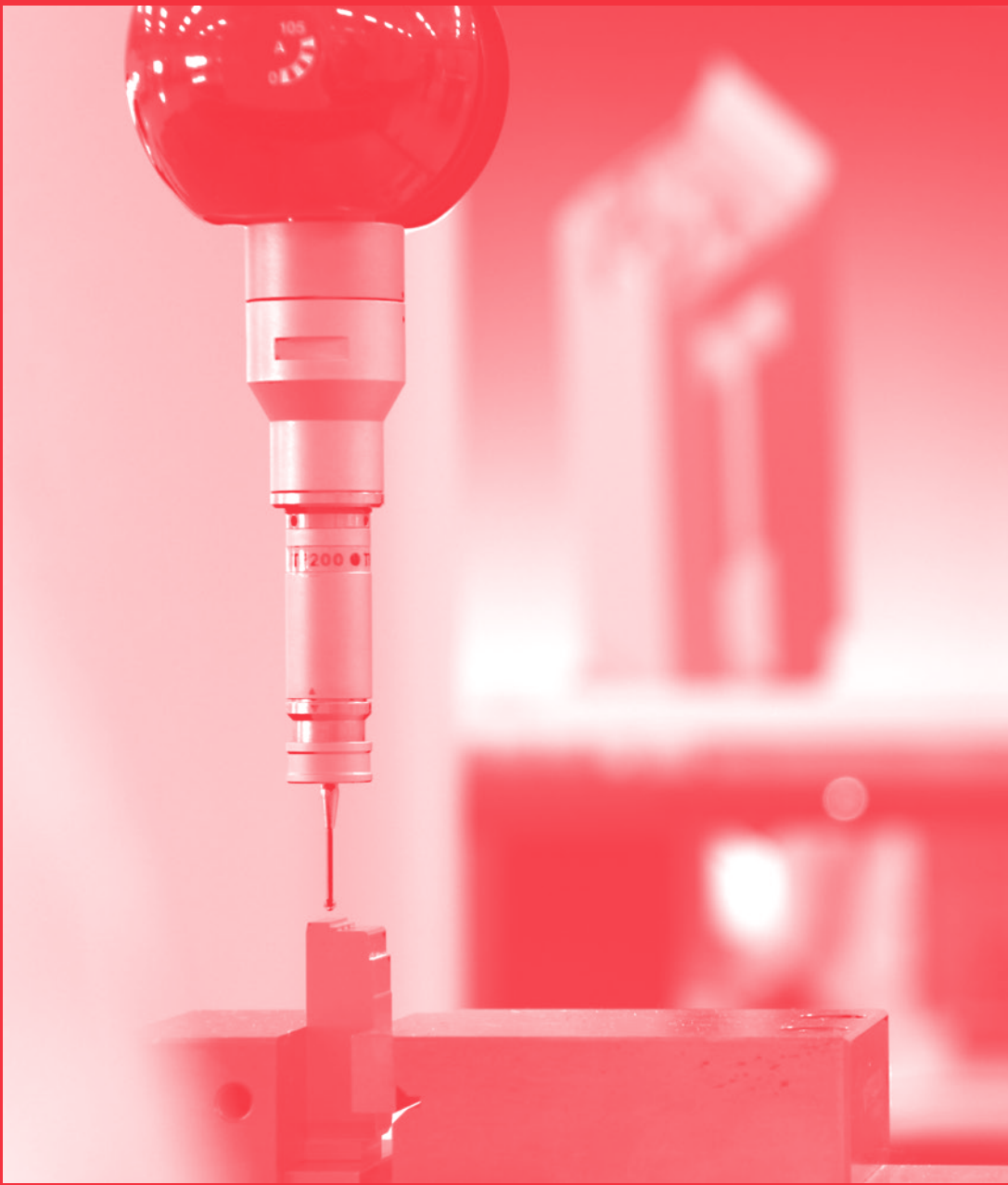

Ci piacciono le cose **fatte bene**, e crediamo che *made in Italy* significhi anche saper rispondere con massima competenza e velocità alle richieste dei nostri clienti.

We take care about **quality** and we believe that *made in Italy* means also to be able to give a quick and competent feedback to our customers.

SETTORI DI APPLICAZIONE

APPLICATION SECTORS

- Grandi elettrodomestici
- Piccoli elettrodomestici
- Componenti
- Motori elettrici
- Attrezzature
- Automotive

- Big white goods
- Small white goods
- Components
- Electric motors
- Tooling
- Automotive

IL PIANETA

THE PLANET

La nostra azienda è circondata da terreni coltivati: forse è anche per questo che l'**ambiente** è sempre stato fra le nostre priorità.

Our factory is surrounded by cultivated fields: maybe this is the reason why the **environment** has always been a priority for us.

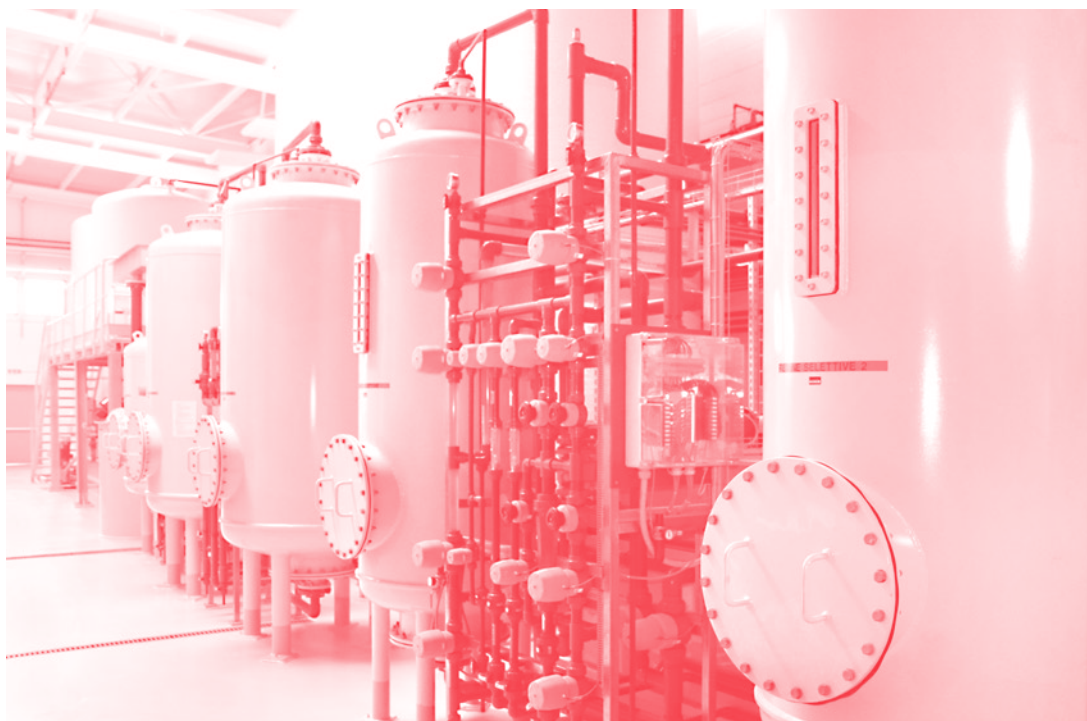



LE PERSONE

THE PEOPLE

Le persone, la risorsa più importante.
Crediamo nella loro crescita alla quale
contribuiamo con più di **15.000** ore
di formazione annua.

People, the most important resource.
We believe in their growth that we support
with **15.000** hours training per year.

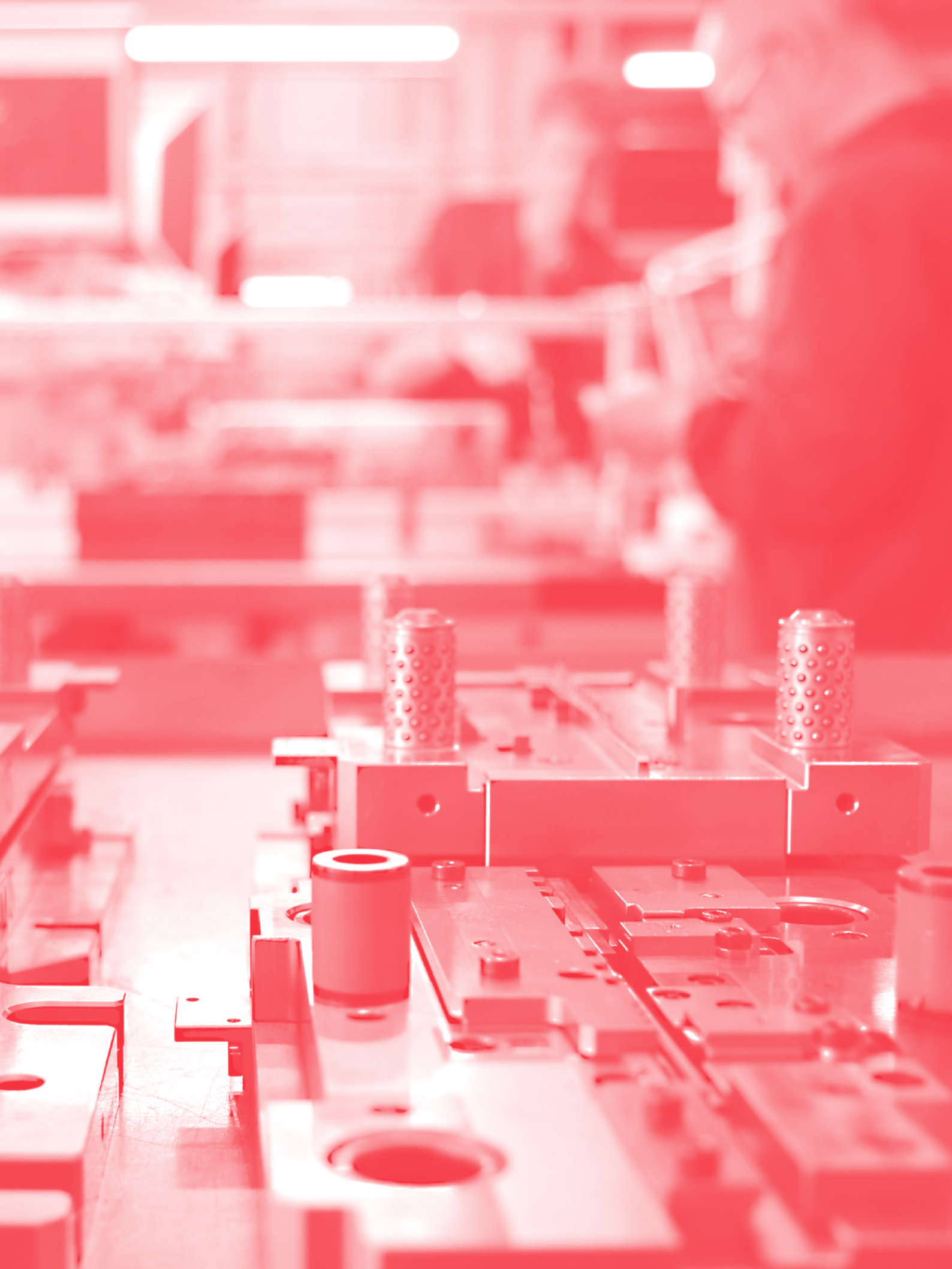

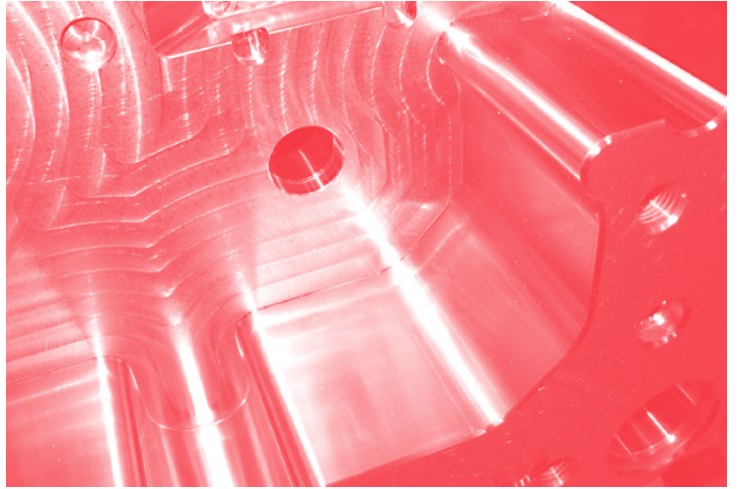
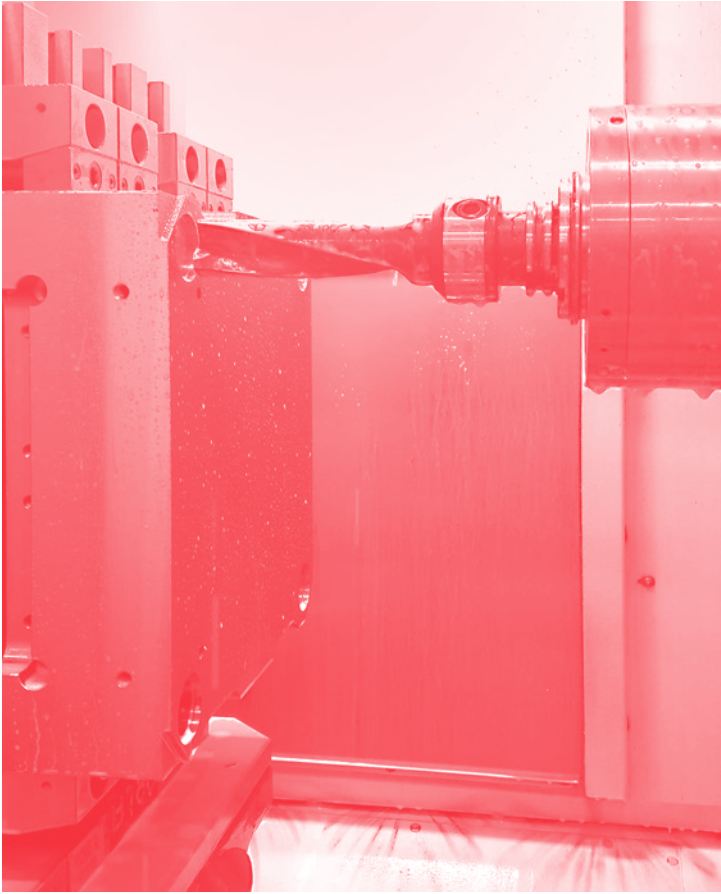



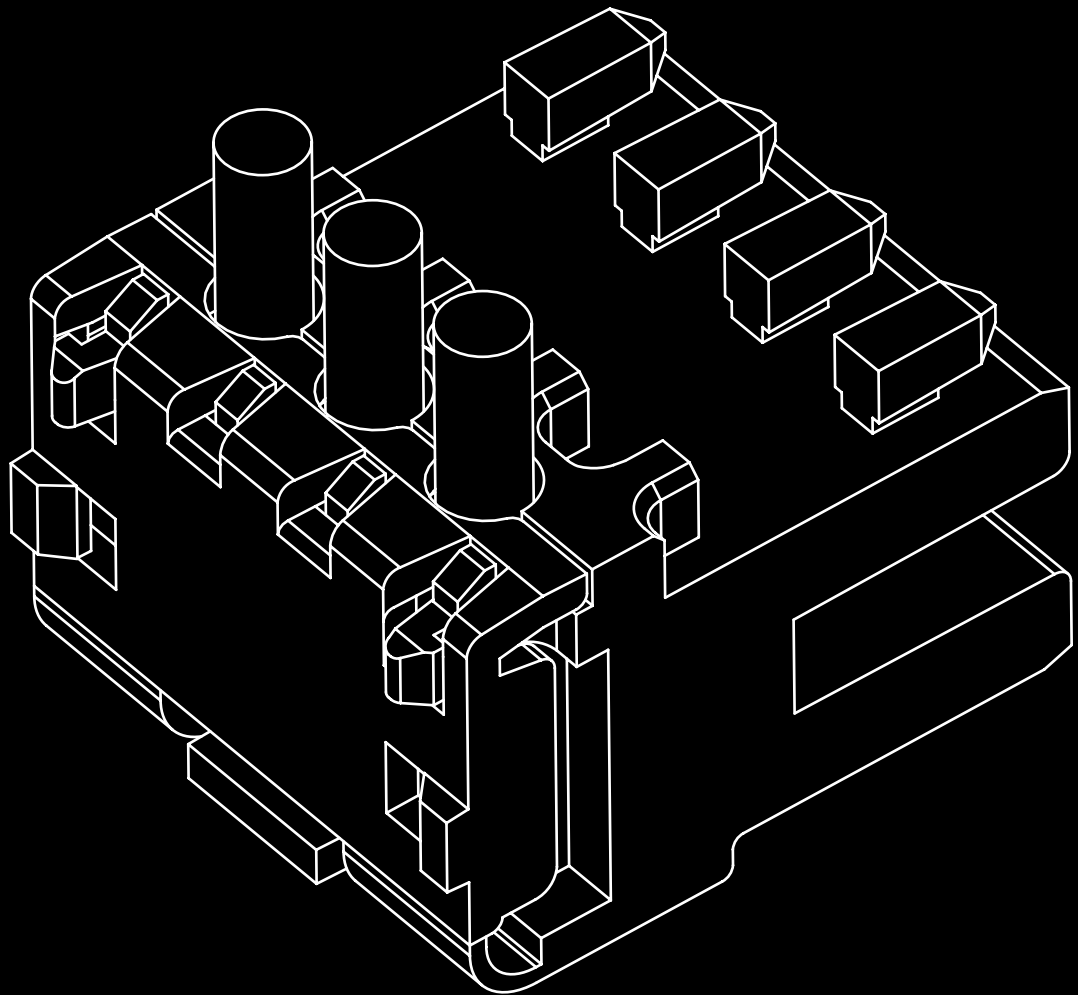

Table of contents

VOL **A**

FLAT QUICK-CONNECT PRODUCTS

VOL **B**

RING AND FORK TERMINALS

VOL **C**

WELDING TABS

VOL **D**

MAGNET WIRE TERMINALS

VOL **E**

INAR-LOCK SYSTEM

VOL **F**

MISCELLANEOUS TERMINALS

VOL **G**

RAST CONNECTOR SYSTEM



Index

G1

027 **CRIMP**

G1.1

029 **PC BOARD**

031 INAR-EDGE PC BOARD RAST 5 CRIMP
CONNECTOR SYSTEM

G1.2

041 **TABS**

043 CONNECTORS RAST 5
MATING TECHNOLOGY

G1.3

059 **RECEPTACLES**

061 INAR-TC RAST 5 CRIMP
CONNECTOR SYSTEM

075 INAR-SAFETY AND INAR-LIF RAST 5
CONNECTOR SYSTEM

083 INAR-LIF FLAG-TYPE RAST 5
CONNECTOR SYSTEM

G2

091 **IDC**

M

151 **TOOLING VOLUME G**

/

161 **ALPHANUMERIC INDEX**

Fundamentals

MATERIALI

I vari impieghi a cui sono destinati i prodotti di questo catalogo comportano l'uso di diversi materiali, ciascuno adatto a particolari condizioni di lavoro (temperatura, umidità, corrosione, elevati passaggi di corrente). Trattamenti superficiali adeguati migliorano le prestazioni elettriche dei materiali metallici, proteggendone allo stesso tempo le superfici.

Ottone: (CuZn) è il materiale più usato nella fabbricazione di questi tipi di terminali e trova il suo impiego senza rivestimento o, più spesso, con un trattamento che ne protegge la superficie.

Bronzo fosforoso: (CuSn) ha le stesse prestazioni elettriche dell'ottone. Il suo uso è indicato in presenza di agenti corrosivi che possono intaccare l'ottone.

Acciaio nichelato: (Steel Nickel Plated) la combinazione di questi due materiali offre la massima garanzia di affidabilità in presenza di alte temperature. I terminali realizzati in acciaio nichelato possono infatti ben sopportare temperature fino a 300°C.

Acciaio inossidabile: (AISI 430 X 8 Cr17, AISI 304 X 8 CrNi 18 10) Impiegato in presenza di temperature elevate, dove l'ottone non garantisce più un'adeguata affidabilità.

Alpacca: (Cu Ni Si Zn) presenta una buona resistenza alla corrosione e alle alte temperature.

Cu Ni Si Mg: lega ad alte prestazioni in termini di conducibilità (quasi doppia rispetto all'ottone), di elasticità e di resistenza alle alte temperature.

Poliammidi: (PA) le resine semicristalline termoplastiche, sono il polimero oggi più comunemente usato. Sono caratterizzate da ottime proprietà meccaniche, resistenza all'usura, basso coefficiente d'attrito, elevato punto di fusione, buona resistenza all'urto, ottime caratteristiche d'isolamento elettrico unite ad ottima resistenza alla maggior parte dei solventi organici. Inoltre sono facilmente stampabili. Esistono formulazioni che presentano caratteristiche di auto estinguenza (UL94-V0). Tramite assorbimento di acqua (umidità ambientale) viene diminuita la rigidità a vantaggio della resistenza all'urto e dell'elasticità dei particolari stampati. Le poliammidi caricate con fibra vetro o carica

MATERIALS

The very different employments the products of the present catalogue are destined to involve the use of different materials, each fit for particular working conditions (temperature, humidity, corrosion, high current flows). Adequate surface treatments improve the electric performances of metallic materials protecting their surfaces at the same time.

Brass: (CuZn) it is the material the most used in the production of this kind of terminals and it finds its effective employment without coating or, more often, with a surface protecting treatment.

Phosphor bronze: (CuSn) it has the same electric performances of brass. Its use is suggested in the presence of corrosion agents which may pit brass.

Nickel-plated steel: (Steel Nickel Plated) the combination of these two materials offers the maximum warranties of reliability in the presence of high temperatures. The terminals made in nickel-plated steel can in fact withstand well temperatures up to 300°C.

Stainless steel: (AISI 430 X 8 Cr17, AISI 304 X 8 CrNi 18 10) it is employed in the presence of high temperatures, where brass does not grant apt reliability any more.

Nickel silver: (Cu Ni Si Zn) has a good resistance to corrosion and to high temperatures.

Cu Ni Si Mg: alloy high performance in terms of conductivity (almost double than brass), elasticity and high temperatures resistance;

Polyamides: (PA) Polyamides, medium thick plate glass thermoplastic resins, are nowadays the most used polymer. They can be distinguished by excellent mechanical properties, wear-proof, low friction coefficient, high melting point, good shock resistance, excellent electrical properties of electrical insulation and excellent resistance to the most organic solvents and easy printable. In some formulations they have self-extinguishing properties (UL94-V0). Through water absorption (environmental humidity) the rigidity is decreased to the advantage of shock resistance and the elasticity of moulded particulars. Polyamides with fiber glass or with mineral improve

minerale migliorano alcune caratteristiche particolari come la rigidità e la stabilità dimensionale anche ad elevate temperature.

Poliesteri: (PBT) resine semicristalline termoplastiche a base di polibutilenterenftalato, sono caratterizzate da ottime proprietà meccaniche, termiche di isolamento elettrico unite ad ottima resistenza chimica e stabilità dimensionale. Esistono formulazioni che presentano caratteristiche di auto estinguenza (UL94-V0). Presentano un bassissimo assorbimento d'acqua che non influenza le caratteristiche meccaniche e di isolamento elettrico. I poliesteri PBT caricati con fibra vetro o carica minerale migliorano alcune caratteristiche particolari come la rigidità e la stabilità dimensionale anche ad elevate temperature.

some particular properties as rigidity and dimensional stability even at high temperatures.

Polyesters: (PBT) PBT polyesters, medium thick plate glass thermoplastic resins with polibutilenterenftalato, can be distinguished by excellent mechanical, thermal properties of electrical insulation together with an excellent chemical resistance and dimensional stability. In some formulations they can reach self-extinguishing properties (UL94-V0). They possess a very low water absorption, which does not influence mechanical and electrical insulation characteristics. PBT polyesters with fiber glass or with mineral improve some particular properties as rigidity and dimensional stability even at high temperatures.

TRATTAMENTI SUPERFICIALI

Stagnatura: consente un'ottima protezione del terminale e assicura buona prestazione elettrica fino a temp. di circa 155°C.

Argentatura: l'ottima conducibilità elettrica, lo rende indispensabile su connessioni con elevati passaggi di corrente: con l'argentatura si migliora inoltre la tenuta termica della connessione, che può sopportare temperature fino a 160°C.

Nichelatura: offre le migliori garanzie in atmosfera a temperatura elevata. Questi sono i nostri trattamenti standard. Altri rivestimenti speciali vengono comunque eseguiti su richiesta.

Doratura: garantisce un'alta resistenza all'ossidazione e all'attacco dei solfati. Conferisce, oltre alla durezza, proprietà di scorrimento molto buone e resistenza di contatto estremamente bassa e costante per tempi molto lunghi.

SURFACE TREATMENTS

Tin plated: allows an excellent protection of the terminal and assures a good electric performance up to temp. of about 155°C.

Silver plated: the excellent electric conductivity makes it indispensable on the connections with high current flows: furthermore the silver-plating improves the connection thermic withstanding, which can allow temperatures up to 160°C.

Nickel plated: it offers the best results in high temperature atmospheres. The ones presented are the standard treatments we offer. Other special treatments are anyway done on request.

Gold Plated: guarantees high resistance to oxidation and sulphate attack. In addition to its hardness, gold plating gives it very good sliding properties and extremely low and constant contact resistance for very long periods.

PROVE DI LABORATORIO

I terminali presentati in questo catalogo sono costruiti tenendo conto delle prescrizioni dettate dai principali istituti di normalizzazione internazionali. La conformità a queste norme comporta un rigoroso e costante controllo di tutti i processi produttivi da garanzia delle qualità dei nostri prodotti. I risultati delle prove elettriche, meccaniche, di resistenza e di durata, cui sottoponiamo i nostri prodotti, sono a disposizione dei nostri clienti.

LABORATORY TESTS

The terminals depicted in the present catalogue are produced keeping count of the prescriptions dictated by the main international standardization institutions. The conformity to these standards involves on our part a strict and constant check of all the production processes, granting our clients the quality and constant grade of our products. The results of the electric, mechanical and strength and endurance tests that our products undergo, are available for the customer who should make request.

LEGENDA

LI = Low Insertion
ES = Extra Spring

LEGEND

LI = Low Insertion
ES = Extra Spring

CODICE A 10 CIFRE

I codici dei prodotti Inarca sono composti da 10 cifre ed hanno una “struttura parlante”:

COMPONENTI IN METALLO

tutti i codici

00 10101201	Tipo di materia prima
00 10 101201	Categoria
0010 10 1201	Numero di matricola
001010 12 01	Rivestimento superficiale
00101012 01	Stato di fornitura

COMPONENTI IN PLASTICA

articolo da codice 001 a codice 340

08 54091700	Materiale termoplastico
08 54 091700	Tipo di materia prima
0854 09 1700	Numero di matricola
085409 17 00	Colorazione
08540917 00	Stato di fornitura

articolo da codice 341

55 50348700	Tipo di materia prima
55 50 348700	Categoria
5550 34 8700	Numero di matricola
5550348 70 0	Colorazione
55503487 00	Stato di fornitura

articolo 8540300701

85 40300701	Tipo di materia prima
85 40 300701	Serie
8540 30 0701	Numero di vie
85403 00 701	Schema
8540300 70 1	Rivestimento superficiale
85403007 01	Stato di fornitura

Questa classificazione consente di comporre il codice corretto del componente in relazione ai diversi materiali e finiture che Inarca ha previsto per ciascun prodotto e che appaiono in questo catalogo. È possibile, per specifico impiego, usare materiali e finiture differenti da quelle proposte.

10 FIGURES CODE

The Inarca product codes consist of 10 figures and have a “speaking structure”:

METAL PARTS

all codes

00 10101201	Type of raw material
00 10 101201	Category
0010 10 1201	Serial number
001010 12 01	Surface coating
00101012 01	Supply status

PLASTIC PARTS

article from code 001 to code 340

08 54091700	Thermoplastic material
08 54 091700	Type of raw material
0854 09 1700	Serial number
085409 17 00	Colorazione
08540917 00	Supply status

article from code 341

55 50348700	Type of raw material
55 50 348700	Category
5550 34 8700	Serial number
5550348 70 0	Colouring
55503487 00	Supply status

article 8540300701

85 40300701	Type of raw material
85 40 300701	Series
8540 30 0701	Ways number
85403 00 701	Scheme
8540300 70 1	Surface coating
85403007 01	Supply status

This classification permits formation of the correct component code in relation to the different materials and finishes which Inarca provides for each product and which appear in this catalogue. Different materials and finishes from those illustrated are available for specific uses.

P • Q • R • S

Le lettere P, Q, R, S che appaiono nelle tabelle dei prodotti indicano il tipo di bobinatura e, quindi, di avanzamento in fase di aggraffatura. I vari casi sono illustrati nelle figure riportate qui sotto.

Fig. 1 – P

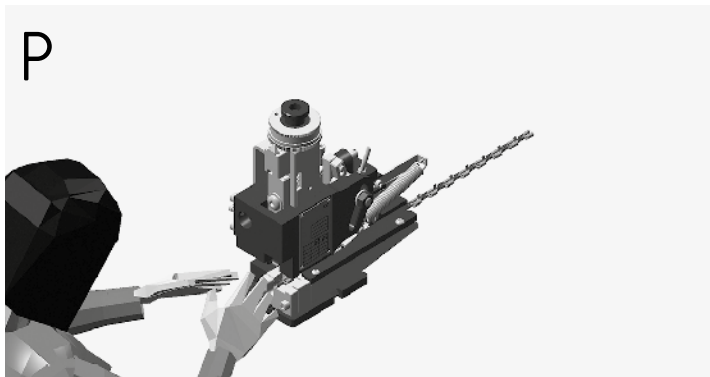
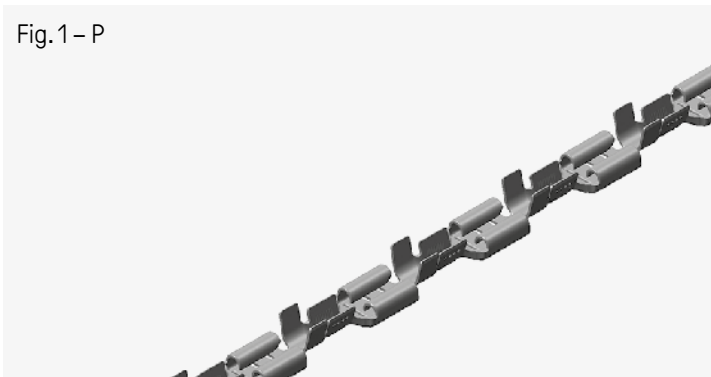

Fig. 2 – Q

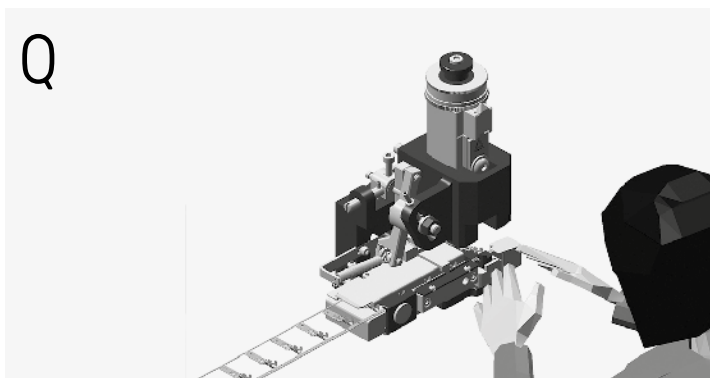
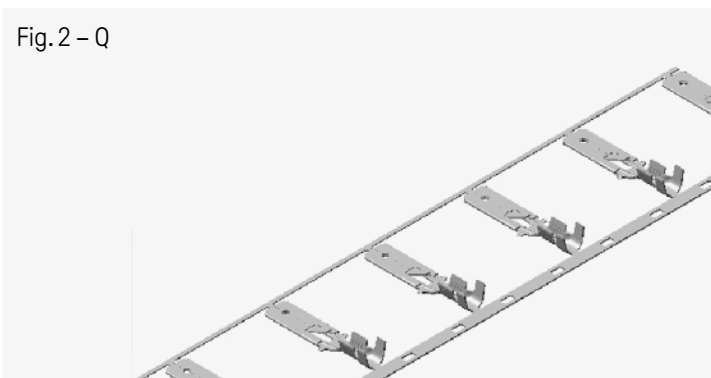

Fig. 3 – R

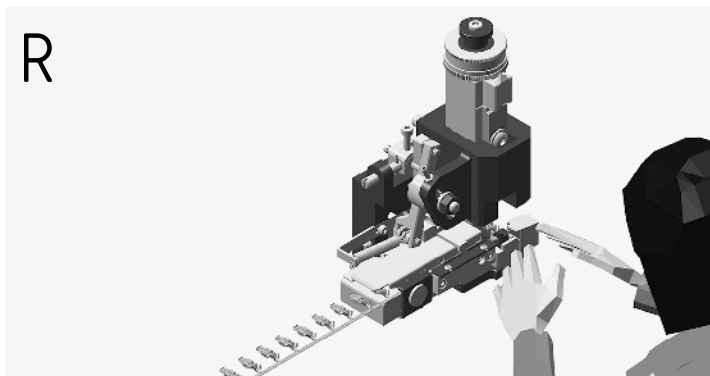
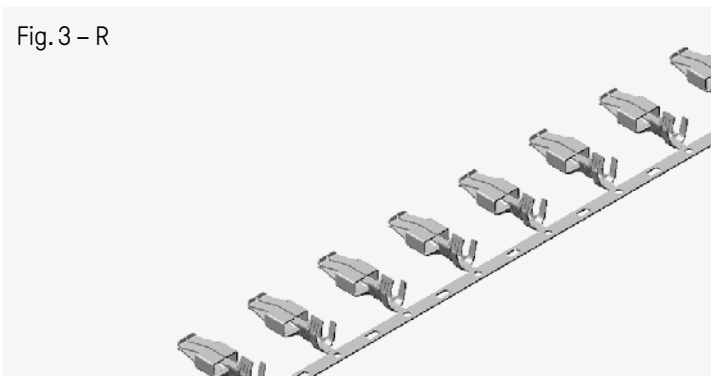
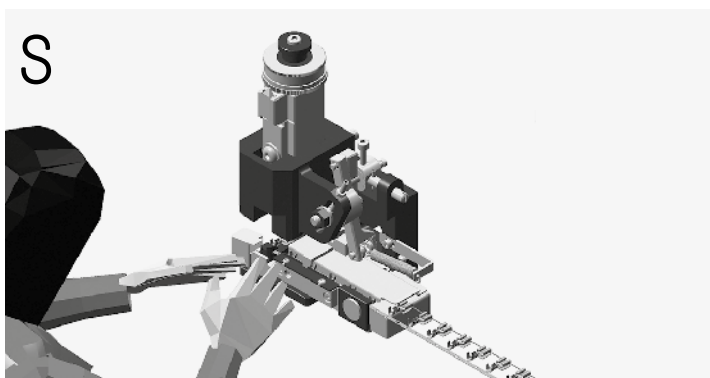
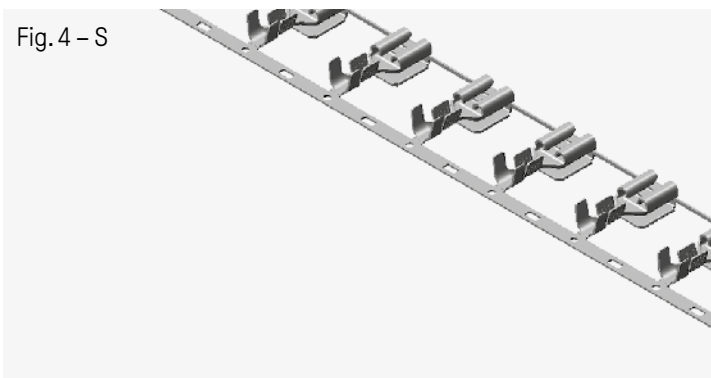

Fig. 4 – S



**TABELLA DI CONVERSIONE
AMERICAN WIRE GAGE (AWG) – mm²**
**CONVERSION TABLE
AMERICAN WIRE GAGE (AWG) – mm²**

AWG	Diametro nominale (pollici) Nominal diameter (inch)	Area calcolata (pollici quadrati) Calculated area (square inch)	Diametro nominale (mm) Nominal diameter (mm)	mm²
6/0	0,5800	0,264208	14,732	170,457
5/0	0,5165	0,209523	13,119	135,174
4/0	0,4600	0,166191	11,684	107,220
3/0	0,4096	0,131768	10,404	85,014
2/0	0,3648	0,104520	9,266	67,433
1/0	0,3249	0,082907	8,252	53,482
1	0,2893	0,065734	7,348	42,406
2	0,2576	0,052117	6,543	33,624
3	0,2294	0,041331	5,827	26,667
4	0,2043	0,032781	5,189	21,148
5	0,1819	0,025987	4,620	16,764
6	0,1620	0,020612	4,115	13,299
7	0,1443	0,016354	3,665	10,550
8	0,1285	0,012969	3,264	8,367
9	0,1144	0,010279	2,906	6,633
10	0,1019	0,008155	2,588	5,260
11	0,0907	0,006461	2,304	4,169
12	0,0808	0,005128	2,052	3,307
13	0,0720	0,004072	1,829	2,627
14	0,0641	0,003227	1,628	2,082
15	0,0571	0,002561	1,450	1,651
16	0,0508	0,002027	1,290	1,307
17	0,0453	0,001612	1,151	1,040
18	0,0403	0,001276	1,024	0,824
19	0,0359	0,001012	0,912	0,653
20	0,0320	0,000804	0,813	0,519
21	0,0285	0,000638	0,724	0,412
22	0,0253	0,000503	0,643	0,325
23	0,0226	0,0004012	0,574	0,259
24	0,0201	0,0003173	0,511	0,205
25	0,0179	0,0002517	0,455	0,163
26	0,0159	0,0001986	0,404	0,128
27	0,0142	0,0001584	0,361	0,102
28	0,0126	0,0001247	0,320	0,080
29	0,0113	0,0001003	0,287	0,065
30	0,0100	0,0000785	0,254	0,051
31	0,0089	0,0000622	0,226	0,040
32	0,0080	0,0000503	0,203	0,032
33	0,0071	0,0000396	0,180	0,025
34	0,0063	0,0000312	0,160	0,020
35	0,0056	0,0000246	0,142	0,016

AWG	Diametro nominale (pollici) Nominal diameter (inch)	Area calcolata (pollici quadrati) Calculated area (square inch)	Diametro nominale (mm) Nominal diameter (mm)	mm²
36	0,0050	0,0000196	0,127	0,013
37	0,0045	0,0000159	0,114	0,010
38	0,0040	0,0000126	0,102	0,0082
39	0,0035	0,0000096	0,089	0,0062
40	0,0031	0,0000076	0,079	0,0049
41	0,0028	0,0000062	0,071	0,0040
42	0,0025	0,0000049	0,064	0,0032
43	0,0022	0,0000038	0,056	0,0025
44	0,00198	0,0000031	0,050	0,0020
45	0,00176	0,0000024	0,045	0,0016
46	0,00157	0,0000019	0,040	0,0013
47	0,00140	0,0000015	0,036	0,0010
48	0,00124	0,0000012	0,031	0,0008
49	0,00111	0,00000097	0,028	0,0006
50	0,00099	0,00000077	0,025	0,0005

Nota: Conversioni teoriche, i valori metrici non sono commerciali.

Note: Theoretical conversions, the metric values are not commercial.

CODICE COLORE

I connettori indicati sono di colore NATURALE. Su richiesta vengono forniti connettori con colorazione codice RAL. Per l'ordinazione sostituire il terzultimo e il penultimo numero del codice con il numero del colore desiderato.

Esempio codifica colore:

Colore naturale
0854091**700**
Colore rosso mattone
0854091**840**

Tabella codici colori:

- 70 NATURALE
- 71 ROSSO
- 72 VERDE
- 73 BLU
- 74 GIALLO
- 75 NERO
- 76 GRIGIO
- 77 ARANCIO
- 78 CELESTE
- 79 GRIGIO CHIARO
- 80 GRIGIO
- 81 GRIGIO
- 82 GIALLO
- 83 BRUNO
- 84 ROSSO MATTONE
- 85 GRIGIO BRUNO
- 86 NERO SPECIALE
- 87 BIANCO
- 88 BEIGE

COLOUR CODE

The connectors indicated are in NATURAL colour. On request we can supply connectors in RAL code colours. To order, please replace the last but two and the last but one code number by the colour number desired.

Colour code example:

Colour code natural
0854091**700**
Colour code brick red
0854091**840**

Colour code table:

- 70 NATURAL
- 71 RED
- 72 GREEN
- 73 BLUE
- 74 YELLOW
- 75 BLACK
- 76 GREY
- 77 ORANGE
- 78 LIGHT BLUE
- 79 LIGHT GREY
- 80 GREY
- 81 GREY
- 82 YELLOW
- 83 BROWN
- 84 BRICK RED
- 85 DARK GREY
- 86 SPECIAL BLACK
- 87 WHITE
- 88 BEIGE

CONFEZIONI

Le confezioni sono disponibili nel sito www.inarca.it

PACKAGE QUANTITY

Packagings are available at the website www.inarca.it

G1

CRIMP

G1.1

PC Board

031 INAR-EDGE PC BOARD RAST 5 CRIMP CONNECTOR SYSTEM

G1.1

INAR-EDGE PC board RAST 5 CRIMP connector system

034 **INAR-EDGE TERMINALS**

035 **INAR-EDGE HOUSINGS**

PRODOTTI INAR-EDGE PER CONNESSIONI SU CIRCUITI STAMPATI

La linea di connessione INAR-EDGE è stata studiata per la connessione multipla filo-schede attraverso prodotti concepiti per la lavorazione su sistemi totalmente automatici. Qualità controllata, riduzione dei costi ed aumento dei profitti, sono i risultati che si raggiungono impiegando i connettori INAR-EDGE, già ampiamente usati con successo nel settore elettrodomestico.

La forma particolare del terminale assicura una eccellente pressione sul circuito stampato, permettendo anche una ottima connessione. INAR-EDGE è stato sviluppato per offrire alcuni importanti vantaggi rispetto ai prodotti simili. INAR-EDGE si può lavorare con sistemi totalmente automatici o flessibili UHM (Universal Harness Maker), ottenendo moduli di cablaggio già pronti e collaudati, per un migliore profitto.

IL TERMINALE

È stato studiato per l'impiego totalmente automatico. Presenta un bassissimo carico di inserimento nel connettore.

CARATTERISTICHE TECNICHE

- Capacità di aggraffatura: 0,25÷0,80 mm²
- Portata di corrente fino a: 6 A
- Passo tra i contatti: 5 mm
- Disponibilità dei connettori: 2-12 vie (con o senza polarizzazioni)

I CONNETTORI

Hanno una forma studiata per inserire i terminali con grandissima facilità. Hanno un ingombro bassissimo che consente il loro impiego anche in presenza di spazi ridotti. I connettori in plastica INAR-EDGE sono costruiti con materiali autoestinguenti secondo UL 94 V-2 e V-0 (sono inoltre disponibili materiali plastici autoestinguenti che superano la prova al filo incandescente GWT 750°C senza fiamma). I connettori indicati sono di color NATURALE.

Su richiesta vengono forniti connettori con colorazione codice RAL. Per l'ordinazione sostituire il terzo e il penultimo numero del codice con il numero del colore desiderato.

OMOLOGAZIONI

I prodotti Inarca rispondono alle norme internazionali. Elenchi omologazioni UL e VDE disponibile su richiesta.

INAR-EDGE PRODUCTS FOR PRINTED CIRCUIT CONNECTIONS

The INAR-EDGE connection line has been developed for multiple connection of the wire-card through products designed for working with totally automatic systems. Quality control, reduction of costs and profit increase are all the objectives which can be reached by using the INAR-EDGE connectors, which are already widely used, with success, in the domestic appliances sector.

The special shape of the terminal assures excellent pressure on the printed circuit; consequently the connection also is extremely reliable. INAR-EDGE has been studied to offer more and it presents some important advantages in relation to similar products. INAR-EDGE can work with totally automatic or flexible UHM (Universal Harness Maker) systems, obtaining wiring modules which are ready and tested, all of which is to your advantage.

THE TERMINAL

Has been studied for totally automatic use. It presents a very low insertion load in the contactor.

TECHNICAL CHARACTERISTIC

- Crimping capacity: 0,25÷0,80 mm²
- Current capacity up to: 6 A
- Pitch between the contacts: 5 mm
- Connector availability: 2-12 ways (with or without polarization)

THE CONNECTORS

The form of the connectors have been studied so that the terminals can be easily inserted. Their overall dimensions are very small which makes it possible to put them in a reduced space. INAR-EDGE plastic connectors are made of self extinguishing materials, as required by UL 94 V-2 and V-0 (moreover, plastic auto-extinguish materials are available which can pass the incandescent wire test GWT 750°C no flame). The connectors indicated are in NATURAL col.

On request we can supply connectors in RAL code colours. To order, please replace the last but two and the last but one code number by the colour number desired.

APPROVAL

Inarca products comply with international regulations. UL and VDE approval lists are available on request.

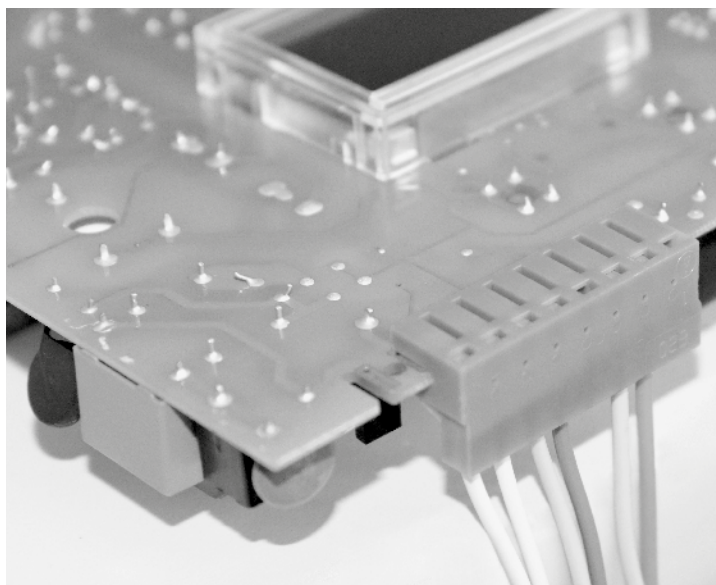

MATERIALI

(vedi pagina 020)

TRATTAMENTI SUPERFICIALI

(vedi pagina 021)

CODICE COLORE

(vedi pagina 026)

CONFEZIONI

Le confezioni sono disponibili nel sito www.inarca.it

MATERIALS

(see page 020)

SURFACE TREATMENTS

(see page 021)

COLOUR CODE

(see page 026)

PACKAGE QUANTITY

Packagings are available at the website www.inarca.it

INAR-EDGE TERMINALI PER CIRCUITO STAMPATO

INAR-EDGE TERMINALS FOR PC BOARD

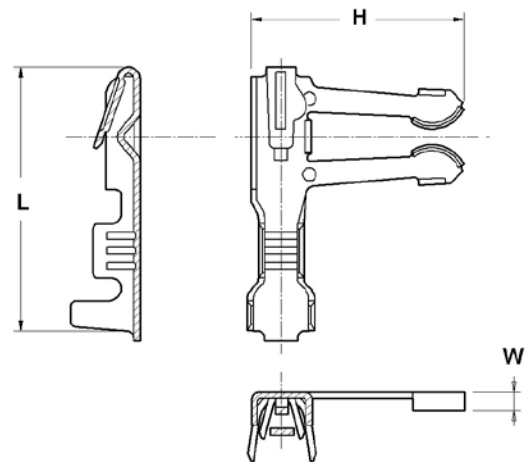

Sez. cavo Wire size (mm ²)	Isolante Insulation (mm)	H	Spess. mat. Stock thk (mm)	R	L	W	Materiale Material	Finitura Plating material	Articolo N° P.N.	Note Notes
0,25 ÷ 0,75 (AWG 23 ÷ 18)	1,5 ÷ 2,2	11,3	0,35	×	14	1	CuZn	Pre-Tinned	0011141101	
							CuSn	Pre-Tinned	0111141101	

INAR-EDGE TERMINALI PER CIRCUITO STAMPATO

INAR-EDGE TERMINALS FOR PC BOARD

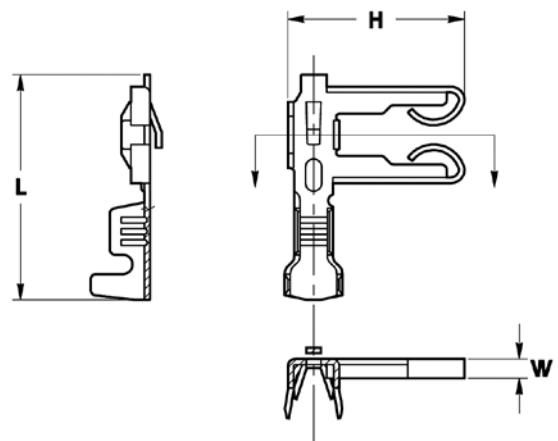

Sez. cavo Wire size (mm ²)	Isolante Insulation (mm)	H	Spess. mat. Stock thk (mm)	R	L	W	Materiale Material	Finitura Plating material	Articolo N° P.N.	Note Notes
0,25 ÷ 0,75 (AWG 23 ÷ 18)	1,5 ÷ 2,2	11	0,35	×	13,3	1,2	CuZn	Pre-Tinned	0011341101	
							CuSn	Pre-Tinned	0111341101	

**INAR-EDGE CONNETTORI
AD ESTREMITÀ APERTA SENZA POLARIZZAZIONE**

INAR-EDGE HOUSINGS OPEN WALL
WITHOUT POLARIZATION

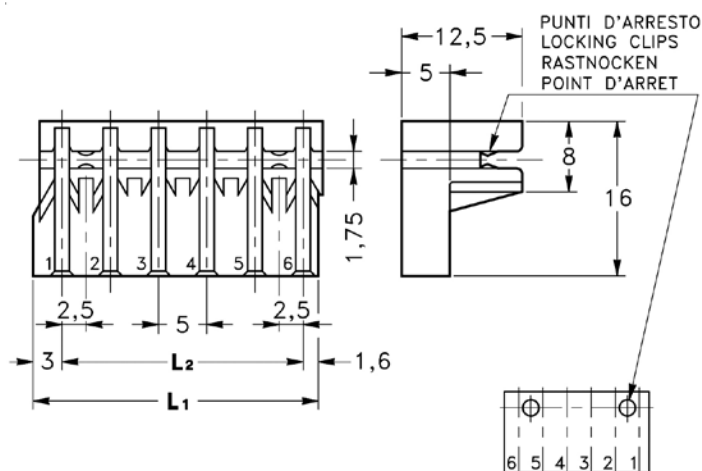

Vie Position	L1	L2	Polarizzazione Polarization	Materiale Material	Articolo N° P.N.	Note Notes
2	9,6	5		PA 66 V-2 PA 66 V-0 PA 66 V-2	0854091700 0855091700 0864091700	
3	14,6	10		PA 66 V-2 PA 66 V-0 PA 66 V-2	0854092700 0855092700 0864092700	





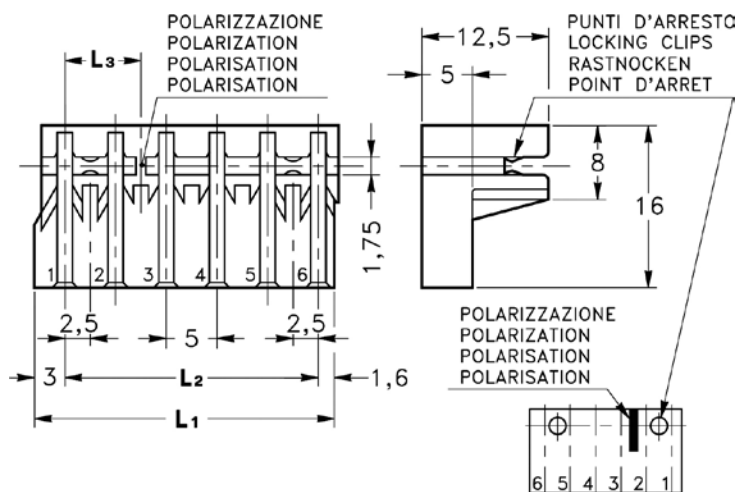

**INAR-EDGE CONNETTORI
AD ESTREMITÀ APERTA CON POLARIZZAZIONE**

INAR-EDGE HOUSINGS OPEN WALL
WITH POLARIZATION

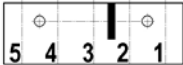
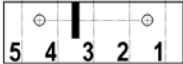
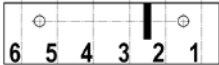

Vie Position	L1	L2	L3	Polarizzazione Polarization	Materiale Material	Articolo N° P.N.	Note Notes
3	14,6	10	2,5		PA 66 V-2 PA 66 V-0 PA 66 V-2	0854285700 0855285700 0864285700	
4	19,6	15	7,5		PA 66 V-2 PA 66 V-0 PA 66 V-2	0854093700 0855093700 0864093700	

Segue • Follow ➔

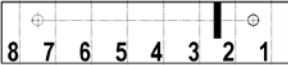
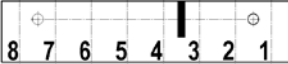
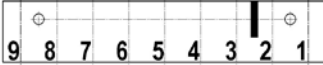
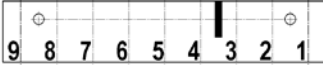
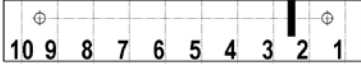
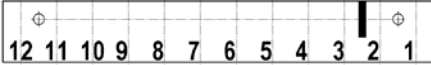
Vie Position	L1	L2	L3	Polarizzazione Polarization	Materiale Material	Articolo N° P.N.	Note Notes
4	19,6	15	2,5		PA 66 V-2	0854298700	
					PA 66 V-0	0855298700	
					PA 66 V-2	0864298700	
4	19,6	15	7,5		PA 66 V-2	5452141700	
					PA 66 V-0	5552141700	
					PA 66 V-2	6452141700	
5	24,6	20	7,5		PA 66 V-2	0854094700	
					PA 66 V-0	0855094700	
					PA 66 V-2	0864094700	
5	24,6	20	12,5		PA 66 V-2	0854299700	
					PA 66 V-0	0855299700	
					PA 66 V-2	0864299700	
6	29,6	25	7,5		PA 66 V-2	0854095700	
					PA 66 V-0	0855095700	
					PA 66 V-2	0864095700	
6	29,6	25	17,5		PA 66 V-2	0854338700	
					PA 66 V-0	0855338700	
					PA 66 V-2	0864338700	
7	34,6	30	22,5		PA 66 V-2	0854096700	
					PA 66 V-0	0855096700	
					PA 66 V-2	0864096700	
7	34,6	30	7,5		PA 66 V-2	0854300700	
					PA 66 V-0	0855300700	
					PA 66 V-2	0864300700	
7	34,6	30	12,5		PA 66 V-2	5450394700	
					PA 66 V-0	5550394700	
					PA 66 V-2	6450394700	
8	39,6	35	7,5		PA 66 V-2	0854097700	
					PA 66 V-0	0855097700	
					PA 66 V-2	0864097700	
8	39,6	35	12,5		PA 66 V-2	5452023700	
					PA 66 V-0	5552023700	
					PA 66 V-2	6452023700	
9	44,6	40	7,5		PA 66 V-2	0854098700	
					PA 66 V-0	0855098700	
					PA 66 V-2	0864098700	
9	44,6	40	12,5		PA 66 V-2	0854301700	
					PA 66 V-0	0855301700	
					PA 66 V-2	0864301700	
10	49,6	45	7,5		PA 66 V-2	0854099700	
					PA 66 V-0	0855099700	
					PA 66 V-2	0864099700	
12	59,6	55	7,5		PA 66 V-2	0854085700	
					PA 66 V-0	0855085700	
					PA 66 V-2	0864085700	

INAR-EDGE CONNETTORI AD ESTREMITÀ CHIUSA SENZA POLARIZZAZIONE

INAR-EDGE HOUSINGS CLOSED WALL
WITHOUT POLARIZATION

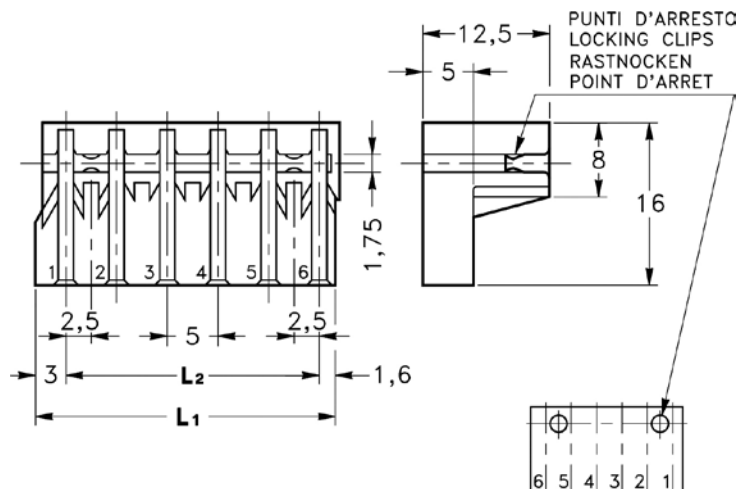

Via Position	L1	L2	Parte chiusa Closed part	Polarizzazione Polarization	Materiale Material	Articolo N° P.N.	Note Notes
2	9,6	5	B		PA 66 V-2 PA 66 V-0 PA 66 V-2	0854105700 0855105700 0864105700	
3	14,6	10	B		PA 66 V-2 PA 66 V-0 PA 66 V-2	0854106700 0855106700 0864106700	
4	19,6	15	B		PA 66 V-2 PA 66 V-0 PA 66 V-2	0854152700 0855152700 0864152700	
5	24,6	20	A		PA 66 V-2 PA 66 V-0 PA 66 V-2	5452149700 5552149700 6452149700	
5	24,6	20	B		PA 66 V-2 PA 66 V-0 PA 66 V-2	0854153700 0855153700 0864153700	
6	29,6	25	B		PA 66 V-2 PA 66 V-0 PA 66 V-2	0854156700 0855156700 0864156700	
7	34,6	30	B		PA 66 V-2 PA 66 V-0 PA 66 V-2	0854157700 0855157700 0864157700	
7	34,6	30	B		PA 66 V-2 PA 66 V-0 PA 66 V-2	0854157700 0855157700 0864157700	
8	39,6	35	B		PA 66 V-2 PA 66 V-0 PA 66 V-2	0854158700 0855158700 0864158700	
9	44,6	40	B		PA 66 V-2 PA 66 V-0 PA 66 V-2	0854159700 0855159700 0864159700	

Segue • Follow ➤

Vie Position	L1	L2	Parte chiusa Closed part	Polarizzazione Polarization	Materiale Material	Articolo N° P.N.	Note Notes
10	49,6	45	B		PA 66 V-2	0854160700	
					PA 66 V-0	0855160700	
					PA 66 V-2	0864160700	
12	59,6	55	B		PA 66 V-2	0854161700	
					PA 66 V-0	0855161700	
					PA 66 V-2	0864161700	

**INAR-EDGE CONNETTORI
AD ESTREMITÀ CHIUSA CON POLARIZZAZIONE**
INAR-EDGE HOUSINGS CLOSED WALL
WITH POLARIZATION

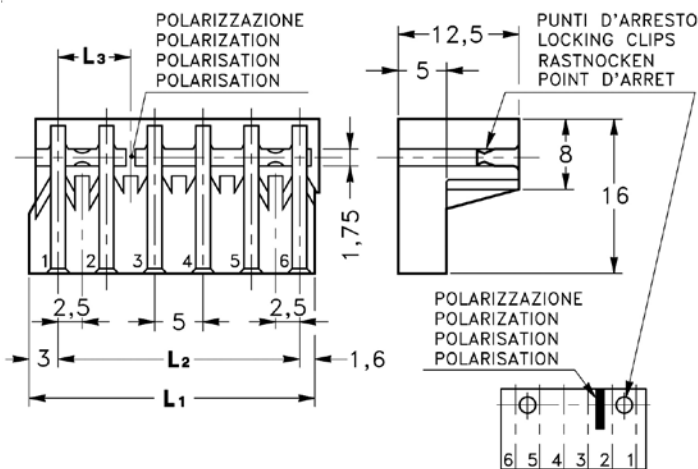

Vie Position	L1	L2	L3	Parte chiusa Closed part	Polarizzazione Polarization	Materiale Material	Articolo N° P.N.	Note Notes
4	19,6	15	7,5	B		PA 66 V-2	0854107700	
						PA 66 V-0	0855107700	
						PA 66 V-2	0864107700	
5	24,6	20	7,5	B		PA 66 V-2	0854108700	
						PA 66 V-0	0855108700	
						PA 66 V-2	0864108700	
6	29,6	25	7,5	B		PA 66 V-2	0854109700	
						PA 66 V-0	0855109700	
						PA 66 V-2	0864109700	
7	34,6	30	22,5	B		PA 66 V-2	0854110700	
						PA 66 V-0	0855110700	
						PA 66 V-2	0864110700	
7	34,6	30	7,5	B		PA 66 V-2	5450399700	
						PA 66 V-0	5550399700	
						PA 66 V-2	6450399700	
8	39,6	35	7,5	B		PA 66 V-2	0854111700	
						PA 66 V-0	0855111700	
						PA 66 V-2	0864111700	

Segue • Follow ➤

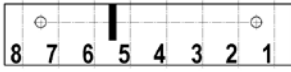
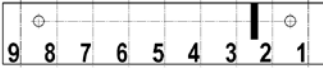
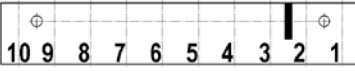
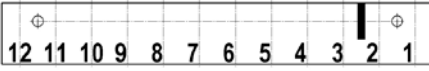
Vie Position	L1	L2	L3	Parte chiusa Closed part	Polarizzazione Polarization	Materiale Material	Articolo N° P.N.	Note Notes
8	39,6	35	22,5	B		PA 66 V-2	0854164700	
						PA 66 V-0	0855164700	
						PA 66 V-2	0864164700	
9	44,6	40	7,5	B		PA 66 V-2	0854112700	
						PA 66 V-0	0855112700	
						PA 66 V-2	0864112700	
10	49,6	45	7,5	B		PA 66 V-2	0854113700	
						PA 66 V-0	0855113700	
						PA 66 V-2	0864113700	
12	59,6	55	7,5	B		PA 66 V-2	0854104700	
						PA 66 V-0	0855104700	
						PA 66 V-2	0864104700	

G1.2

Tabs

043 CONNECTORS RAST 5 MATING TECHNOLOGY

G1.2

Connectors RAST 5
mating technology

- 048 **WIRE CRIMP TABS 6,3**
- 051 **WIRE CRIMP TABS HOUSINGS 6,3 RAST 5**
- 057 **COVER FOR TABS HOUSINGS 6,3 RAST 5**
- 058 **SECONDARY LOCK**

TERMINALI CON DENTINO DI RITENZIONE PER CONNESSIONI MULTIPLE

Hanno come variante principale, rispetto ai terminali per connessioni lamellari standard, la presenza di una lamella di ritegno che consente il sicuro bloccaggio, una volta inseriti nei blocchetti isolanti. Principalmente usati nel settore elettrodomestico ed auto mobilistico, trovano una valida applicazione dovunque si vogliono effettuare valide connessioni multiple e isolate. Questa linea di terminali è disponibile nelle versioni: 6,3 - 4,8 - 2,8. I blocchetti per la connessione multipla sono costruiti per la serie 6,3 nelle versioni a 1-2-3-4-6-8 vie.

CONNETTORI

Sono costruiti con materiali autoestinguenti secondo UL 94 V-2 e V-0 (sono inoltre disponibili materiali plastici autoestinguenti che superano la prova al filo incandescente GWT 750°C senza fiamma).

I connettori indicati sono di color NATURALE. Su richiesta vengono forniti connettori con colorazione codice RAL. Per l'ordinazione sostituire il terzultimo e il penultimo numero del codice con il numero del colore desiderato.

MATERIALI

(vedi pagina 020)

TRATTAMENTI SUPERFICIALI

(vedi pagina 021)

CODICE COLORE

(vedi pagina 026)

CONFEZIONI

Le confezioni sono disponibili nel sito www.inarca.it

TERMINALS WITH LOCKING LANCE FOR MULTIPLE CONNECTIONS

They have as a main difference, with reference to the standard terminals for tab-receptacles connection, the presence of a check small plate which allows a safe locking, once they are inserted in the insulating frames. The employment field for these products is very wide: mainly used in the household appliance and automobile industry they find a useful application wherever one wants to make effective multiple, insulated connections. This line of terminals is available in the following versions: 6,3 - 4,8 - 2,8. The multiple connection frames are produced for the 6,3 series, in the 1-2-3-4-5-6-7-8 sockets versions.

CONNECTORS

Plastic connectors are made of self extinguishing materials, as required by UL 94 V-2 and V-0 (moreover, plastic auto-extinguish materials are available which can pass the incandescent wire test GWT 750°C no flame).

The connectors indicated are in NATURAL colour. On request we can supply connectors in RAL code colours. To order, please replace the last but two and the last but one code number by the colour number desired.

MATERIALS

(see page 020)

SURFACE TREATMENTS

(see page 021)

COLOUR CODE

(see page 026)

PACKAGE QUANTITY

Packagings are available at the website www.inarca.it

**DIMA DI FORATURA
PER CONNETTORI PORTAMASCHI PASSO 5 - 6,3**

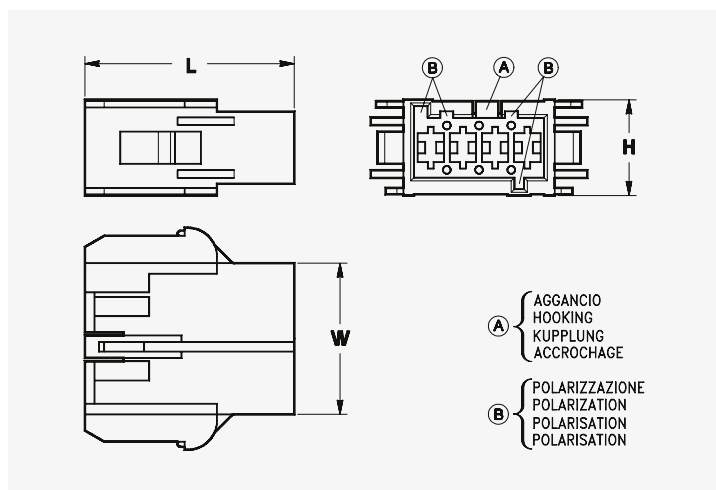

**HOUSING PANEL CUTOUT
FOR TABS HOUSINGS RAST 5 - 6,3**

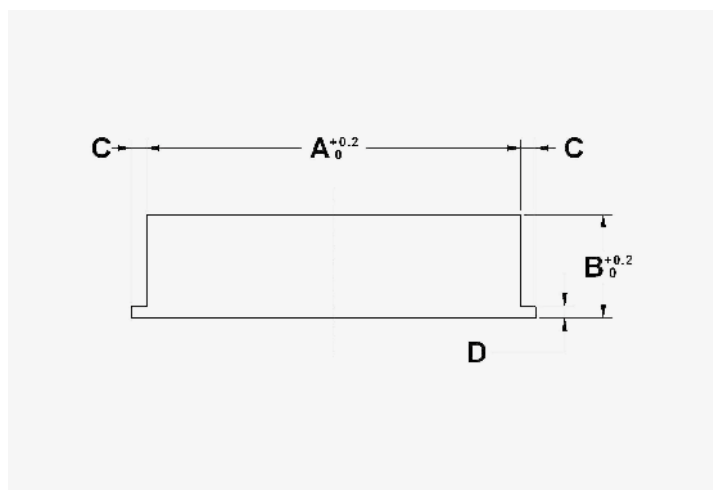

Numero di vie Number of ways	A	B	C	D	Spessore lamiera Plate thickness
3	24	13,5	2	1,5	0,8 ÷ 1
3	29,1	15,2	2	1,5	0,8 ÷ 1
4	29,1	15,2	2	1,5	0,8 ÷ 1
5	34,2	15,2	2,55	2,25	0,8 ÷ 1
7	49,1	13,5	2	1,5	0,8 ÷ 1
8	49,1	13,5	2	1,5	0,8 ÷ 1

**DIMA DI FORATURA
PER CONNETTORI PORTAMASCHI PASSO 5 - 6,3**

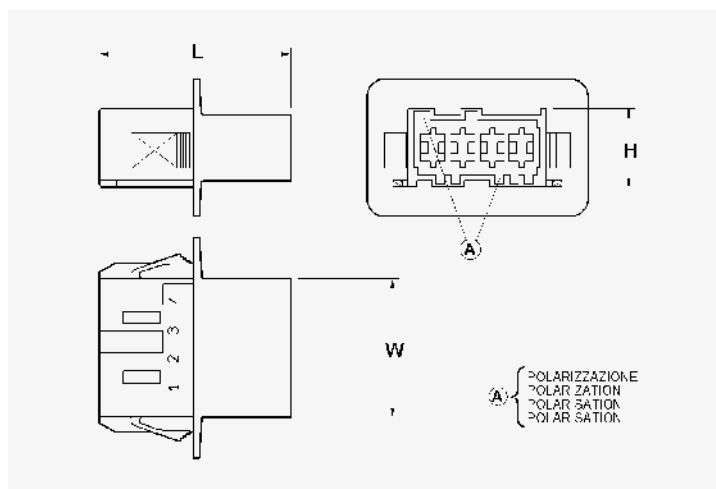

**HOUSING PANEL CUTOUT
FOR TABS HOUSINGS RAST 5 - 6,3**

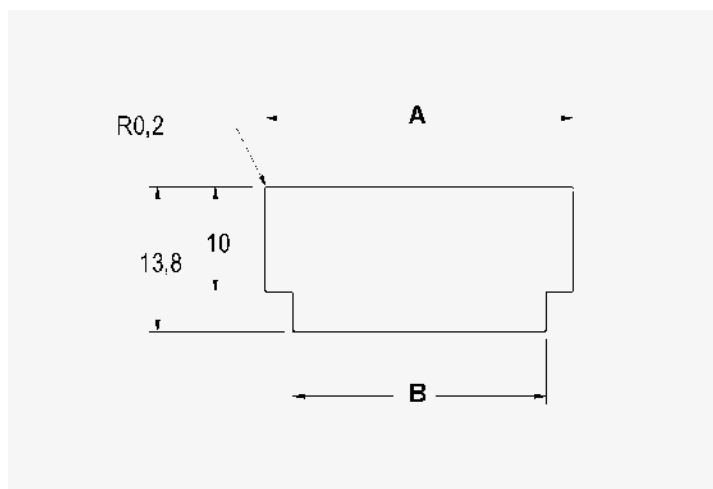

Numero di vie Number of ways	A ± 0,1	+ 0,3 B + 0,1	Spessore lamiera Plate thickness
4	29,2	24	0,8 ÷ 1,8
8	49,1	44	0,8 ÷ 1,8

DIMA DI FORATURA
PER CONNETTORI 10 VIE PORTAMASCHI PASSO 5 - 6,3

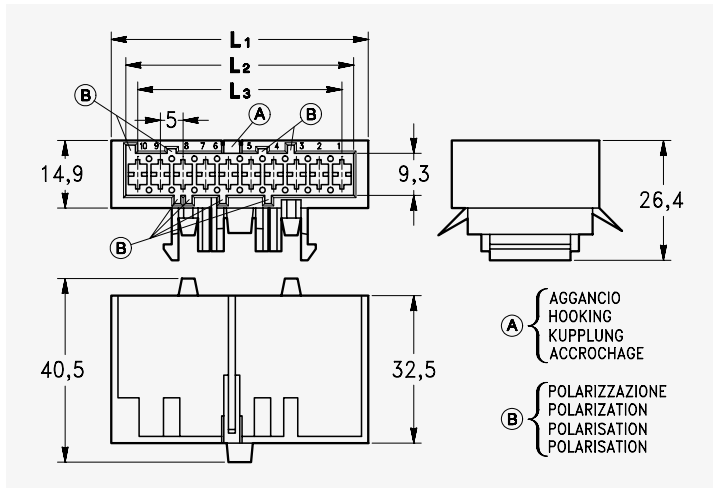

- (A) AGGANCIO
HOOKING
KUPPLUNG
ACCROCHAGE
- (B) POLARIZZAZIONE
POLARIZATION
POLARISATION
POLARISATION

HOUSING PANEL CUTOUT
FOR 10 WAYS TABS HOUSINGS RAST 5 - 6,3

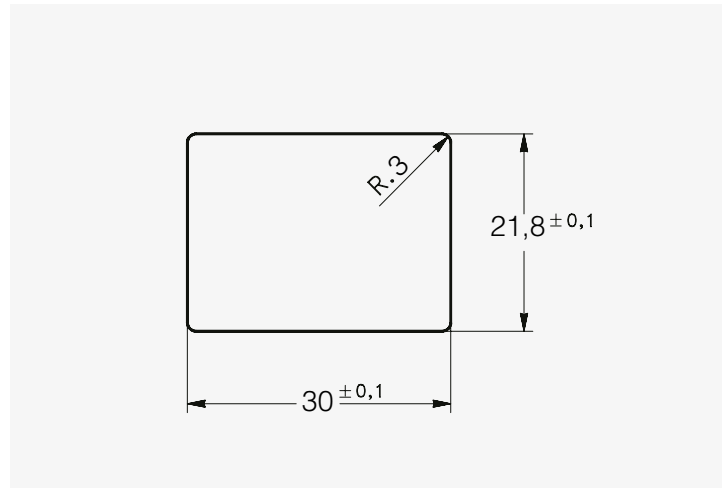

Diametro esterno lamiera
 External diameter of plate

160

Spessore lamiera
 Plate thickness

1,4

DIMA DI FORATURA
PER CONNETTORI 10 VIE PORTAMASCHI PASSO 5 - 6,3
 ADATTO PER INSERIMENTO RITENZIONE SECONDARIA

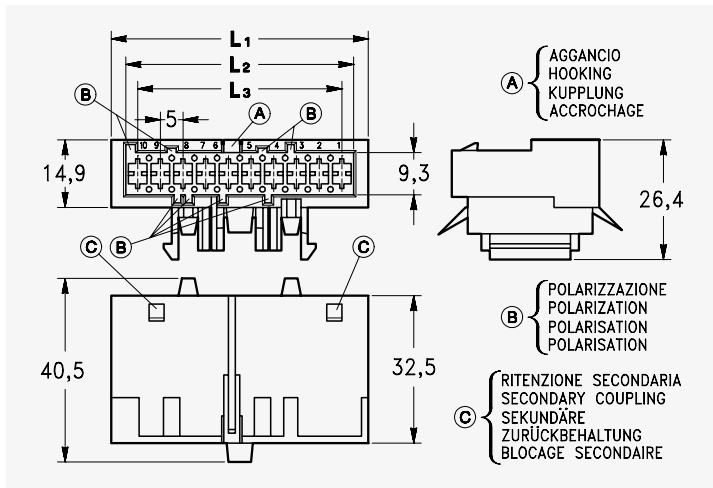

- (A) AGGANCIO
HOOKING
KUPPLUNG
ACCROCHAGE
- (B) POLARIZZAZIONE
POLARIZATION
POLARISATION
POLARISATION
- (C) RITENZIONE SECONDARIA
SECONDARY COUPLING
SEKUNDÄRE
ZURÜCKBEHALTUNG
BLOCAGE SECONDAIRE

HOUSING PANEL CUTOUT
FOR 10 WAYS TABS HOUSINGS RAST 5 - 6,3
 SUITABLE FOR THE INSERTION OF A SECONDARY LOCK

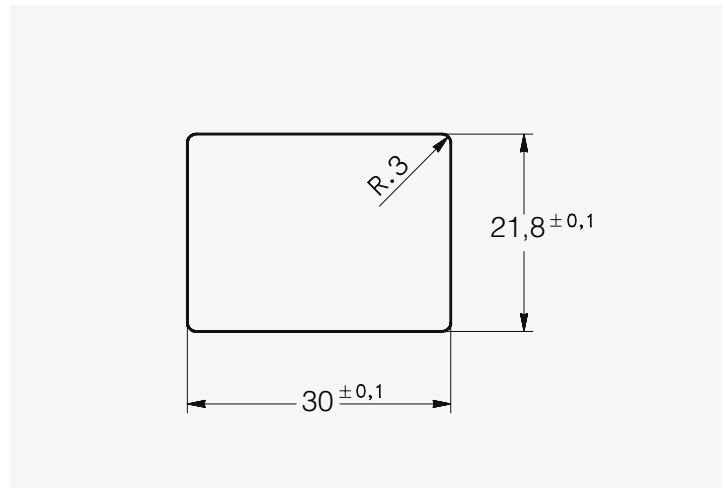

Diametro esterno lamiera
 External diameter of plate

160

Spessore lamiera
 Plate thickness

1,4

DIMA DI FORATURA**PER CONNETTORI 10 VIE PORTAMASCHI PASSO 5 - 6,3**

ADATTO PER INSERIMENTO RITENZIONE SECONDARIA
CON PARACQUA

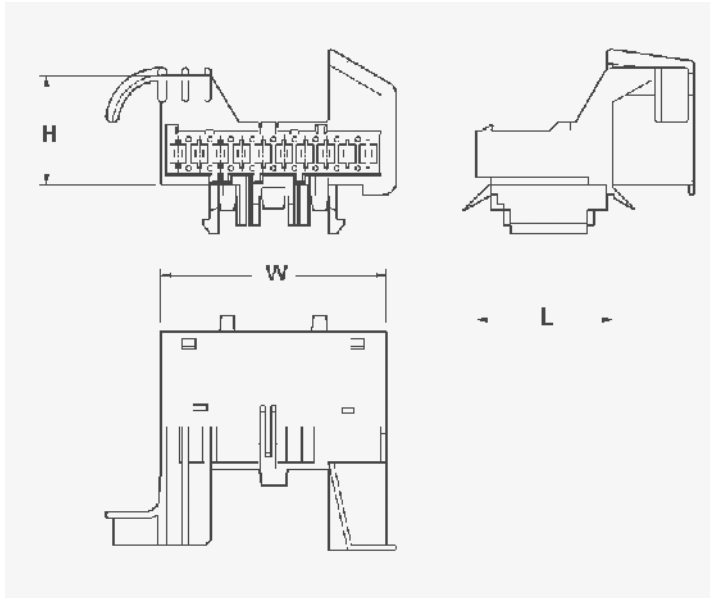
**HOUSING PANEL CUTOUT****FOR 10 WAYS TABS HOUSINGS RAST 5 - 6,3**

SUITABLE FOR THE INSERTION OF A SECONDARY LOCK
WITH WATER PROTECTION

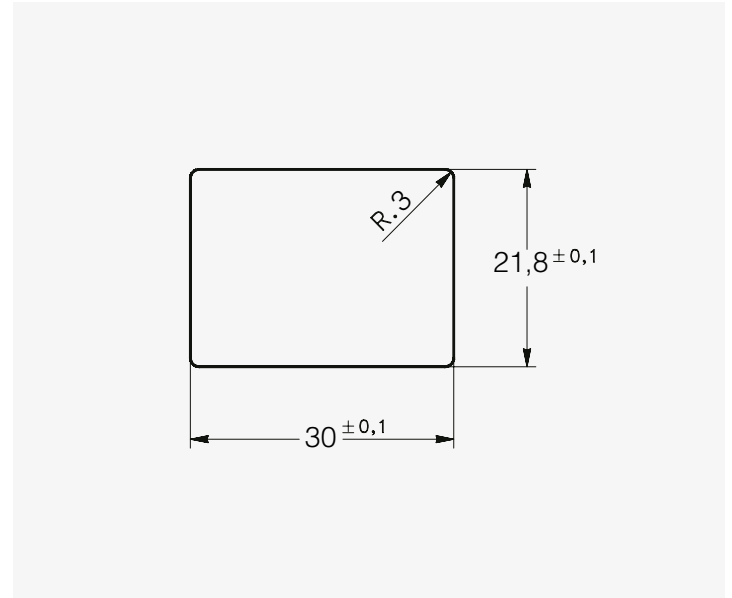

Diametro esterno lamiera
External diameter of plate

Spessore lamiera
Plate thickness

160

1,4

**TERMINALI MASCHIO DIRITTI 6,3
PER CONNESSIONI MULTIPLE (CON DENTINO)**
WIRE CRIMP TABS 6,3 FOR MULTI-WAY CONNECTIONS
(WITH LOCKING LANCE)

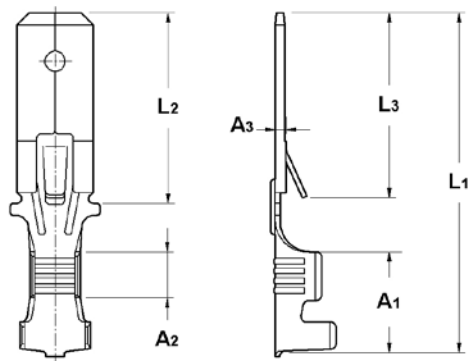

Sez. cavo Wire size (mm ²)	Isolante Insulation (mm)	Dim. maschio Mating tab thk (mm)	Spess. mat. Stock thk (mm)	P	Q	A1	A2	A3	L1	L2	L3	Materiale Material	Finitura Plating material	Articolo N° P.N.	Note Notes
0,25 ÷ 0,75 (AWG 23 ÷ 18)	1,5 ÷ 2,2	0,8	0,38		x	8,2	4,5	0,9	28	15,7	15,3	CuZn		0010846001	
												CuZn	Tin Plated	0010846201	
												CuSn		0110846001	
												CuSn	Tin Plated	0110846201	
0,25 ÷ 0,75 (AWG 23 ÷ 18)	1,5 ÷ 2,2	0,8	0,38	x		8,2	4,5	0,9	28	15,7	15,3	CuZn		0011546001	
												CuZn	Tin Plated	0011546201	
												CuSn		0111546001	
												CuSn	Tin Plated	0111546201	
0,25 ÷ 0,75 (AWG 23 ÷ 18)	1,5 ÷ 2,2	0,8	0,38		x	8,2	4,5	0,8	28	15,7	15,3	CuZn		0011554001	
												CuZn	Tin Plated	0011554201	
												CuSn		0111554001	
												CuSn	Tin Plated	0111554201	
0,25 ÷ 0,75 (AWG 23 ÷ 18)	1,5 ÷ 2,2	0,8	0,38	x		8,2	4,5	0,8	28	15,7	15,3	CuZn		0011575001	
												CuZn	Tin Plated	0011575201	
												CuSn		0111575001	
												CuSn	Tin Plated	0111575201	
0,5 ÷ 1,5 (AWG 20 ÷ 15)	1,9 ÷ 3,3	0,8	0,38	x		8,2	4	0,9	28	15,7	15,3	CuZn		0010980001	
												CuZn	Tin Plated	0010980201	
												CuSn		0110980001	
												CuSn	Tin Plated	0110980201	
0,5 ÷ 1,5 (AWG 20 ÷ 15)	1,9 ÷ 3,3	0,8	0,38	x		8,2	4	0,8	28	15,7	15,3	CuZn		0011577001	
												CuZn	Tin Plated	0011577201	
												CuSn		0111577001	
												CuSn	Tin Plated	0111577201	
1 ÷ 2,5 (AWG 17 ÷ 13)	2,5 ÷ 4	0,8	0,38	x		8,2	4	0,9	28	15,7	15,3	CuZn		0010689001	
												CuZn	Tin Plated	0010689201	
												CuSn		0110689001	
												CuSn	Tin Plated	0110689201	

Segue • Follow ➤

Sez. cavo Wire size (mm ²)	Isolante Insulation (mm)	Dim. maschio Mating tab thk (mm)	Spess. mat. Stock thk (mm)	P	Q	A1	A2	A3	L1	L2	L3	Materiale Material	Finitura Plating material	Articolo N° P.N.	Note Notes
1 ÷ 2,5 (AWG 17 ÷ 13)	2,5 ÷ 4	0,8	0,38	×		8,2	4	0,8	28	15,7	15,3	CuZn		0011579001	
												CuZn	Tin Plated	0011579201	
												CuSn		0111579001	
												CuSn	Tin Plated	0111579201	
3 ÷ 6 (AWG 12 ÷ 9)	4,2 ÷ 5,1	0,8	0,38	×		8,2	4	0,9	28	15,7	15,3	CuZn		0011019001	
												CuZn	Tin Plated	0011019201	
												CuSn		0111019001	
												CuSn	Tin Plated	0111019201	
3 ÷ 6 (AWG 12 ÷ 9)	4,2 ÷ 5,1	0,8	0,38	×		8,2	4	0,8	28	15,7	15,3	CuZn		0011581001	
												CuZn	Tin Plated	0011581201	
												CuSn		0111581001	
												CuSn	Tin Plated	0111581201	

**TERMINALI MASCHIO DIRITTI 6,3 PER CONNESSIONI
MULTIPLE (CON DENTINO) SENZA BUGNA**
WIRE CRIMP TABS 6,3 FOR MULTI-WAY CONNECTIONS
(WITH LOCKING LANCE) WITHOUT BOSS

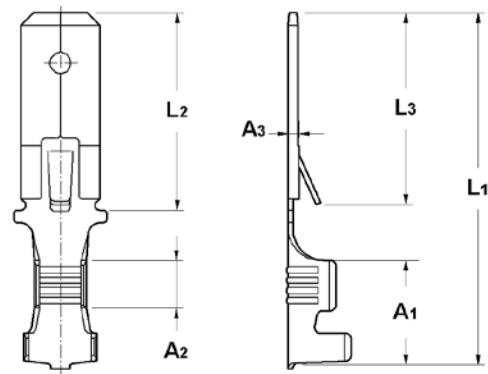

Sez. cavo Wire size (mm ²)	Isolante Insulation (mm)	Dim. maschio Mating tab thk (mm)	Spess. mat. Stock thk (mm)	P	A1	A2	A3	L1	L2	L3	Materiale Material	Finitura Plating material	Articolo N° P.N.	Note Notes
1 ÷ 2,5 (AWG 17 ÷ 13)	2,5 ÷ 4	0,8	0,38	×	8,2	4	0,9	28	15,7	15,3	CuZn		0011216001	
											CuZn	Tin Plated	0011216201	
											CuSn		0111216001	
											CuSn	Tin Plated	0111216201	
1 ÷ 2,5 (AWG 17 ÷ 13)	2,5 ÷ 4	0,8	0,38	×	8,2	4	0,8	28	15,7	15,3	CuZn		0011582001	
											CuZn	Tin Plated	0011582201	
											CuSn		0111582001	
											CuSn	Tin Plated	0111582201	

**TERMINALI MASCHIO DIRITTI 6,3 PER CONNESSIONI
MULTIPLE (CON DENTINO) SENZA FORO**
WIRE CRIMP TABS 6,3 FOR MULTI-WAY CONNECTIONS
(WITH LOCKING LANCE) WITHOUT HOLE

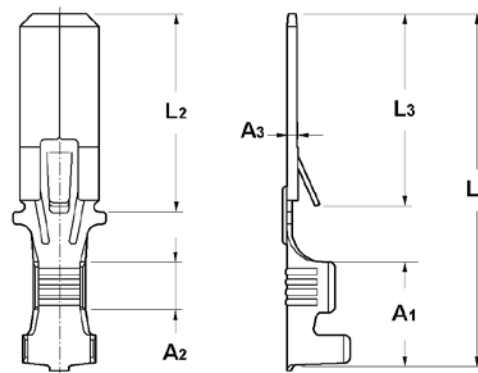

Sez. cavo Wire size (mm ²)	Isolante Insulation (mm)	Dim. maschio Mating tab thk (mm)	Spess. mat. Stock thk (mm)	P	Q	A1	A2	A3	L1	L2	L3	Materiale Material	Finitura Plating material	Articolo N° P.N.	Note Notes
0,25 ÷ 0,75 (AWG 23 ÷ 18)	1,5 ÷ 2,2	0,8	0,38	x		8,2	4,5	0,9	28	15,7	15,3	CuZn		0010847001	
												CuZn	Tin Plated	0010847201	
												CuSn		0110847001	
												CuSn	Tin Plated	0110847201	
0,25 ÷ 0,75 (AWG 23 ÷ 18)	1,5 ÷ 2,2	0,8	0,38	x		8,2	4,5	0,9	28	15,7	15,3	CuZn		0011547001	
												CuZn	Tin Plated	0011547201	
												CuSn		0111547001	
												CuSn	Tin Plated	0111547201	
0,25 ÷ 0,75 (AWG 23 ÷ 18)	1,5 ÷ 2,2	0,8	0,38	x		8,2	4,5	0,8	28	15,7	15,3	CuZn		0011574001	
												CuZn	Tin Plated	0011574201	
												CuSn		0111574001	
												CuSn	Tin Plated	0111574201	
0,5 ÷ 1,5 (AWG 20 ÷ 15)	1,9 ÷ 3,3	0,8	0,38	x		8,2	4	0,9	28	15,7	15,3	CuZn		0010981001	
												CuZn	Tin Plated	0010981201	
												CuSn		0110981001	
												CuSn	Tin Plated	0110981201	
0,5 ÷ 1,5 (AWG 20 ÷ 15)	1,9 ÷ 3,3	0,8	0,38	x		8,2	4	0,8	28	15,7	15,3	CuZn		0011576001	
												CuZn	Tin Plated	0011576201	
												CuSn		0111576001	
												CuSn	Tin Plated	0111576201	
1 ÷ 2,5 (AWG 17 ÷ 13)	2,5 ÷ 4	0,8	0,38	x		8,2	4	0,9	28	15,7	15,3	CuZn		0010375001	
												CuZn	Tin Plated	0010375201	
												CuSn		0110375001	
												CuSn	Tin Plated	0110375201	
1 ÷ 2,5 (AWG 17 ÷ 13)	2,5 ÷ 4	0,8	0,38	x		8,2	4	0,8	28	15,7	15,3	CuZn		0011578001	
												CuZn	Tin Plated	0011578201	
												CuSn		0111578001	
												CuSn	Tin Plated	0111578201	

Segue • Follow ➤

Sez. cavo Wire size (mm ²)	Isolante Insulation (mm)	Dim. maschio Mating tab thk (mm)	Spess. mat. Stock thk (mm)	P	Q	A1	A2	A3	L1	L2	L3	Materiale Material	Finitura Plating material	Articolo N° P.N.	Note Notes
3 ÷ 6 (AWG 12 ÷ 9)	4,2 ÷ 5,1	0,8	0,38	x		8,2	4	0,9	28	15,7	15,3	CuZn		0010987001	
												CuZn	Tin Plated	0010987201	
												CuSn		0110987001	
												CuSn	Tin Plated	0110987201	
3 ÷ 6 (AWG 12 ÷ 9)	4,2 ÷ 5,1	0,8	0,38	x		8,2	4	0,8	28	15,7	15,3	CuZn		0011580001	
												CuZn	Tin Plated	0011580201	
												CuSn		0111580001	
												CuSn	Tin Plated	0111580201	

CONNETTORI PORTA MASCHI 6,3 PASSO 5
WIRE CRIMP TABS HOUSINGS 6,3 RAST 5

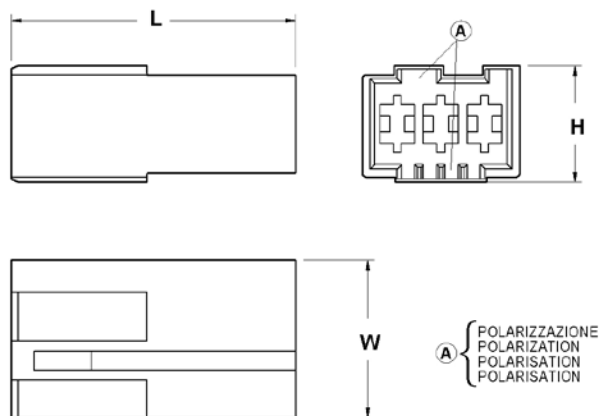

Vie Position	H	L	W	Polarizzazione Polarization	Materiale Material	Articolo N° P.N.	Note Notes
3	13,3	32,5	18		PA 66 V-2	5452008700	
					PA 66 V-0	5552008700	
					PA 66 V-2	6452008700	
6	13,6	32,5	33,5		PA 66 V-2	0854266700	
					PA 66 V-0	0855266700	
					PA 66 V-2	0864266700	

CONNETTORI PORTA MASCHI 6,3
PASSO 5 CON AGGANCI
 WIRE CRIMP TABS HOUSINGS 6,3
 RAST 5 WITH HOOKS

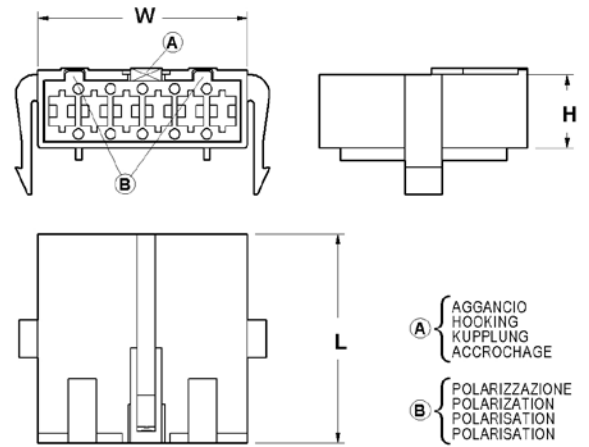

Vie Position	H	L	W	Polarizzazione Polarization	Materiale Material	Articolo N° P.N.	Note Notes
6	11,4	32,5	32,6		PA 66 V-2	0854296700	
					PA 66 V-0	0855296700	
					PA 66 V-2	0864296700	

CONNETTORI PORTA MASCHI 6,3
PASSO 5 CON AGGANCI
 WIRE CRIMP TABS HOUSINGS 6,3
 RAST 5 WITH HOOKS

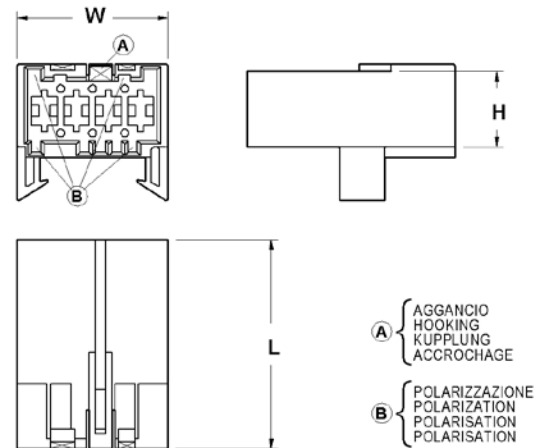

Vie Position	H	L	W	Polarizzazione Polarization	Materiale Material	Articolo N° P.N.	Note Notes
4	11,2	32,5	23,5		PA 66 V-2	5450359700	
					PA 66 V-0	5550359700	
					PA 66 V-2	6450359700	

**CONNETTORI PORTA MASCHI 6,3
PASSO 5 CON AGGANCI PER MOTORE**
WIRE CRIMP TABS HOUSINGS 6,3
RAST 5 WITH HOOKS FOR MOTORS

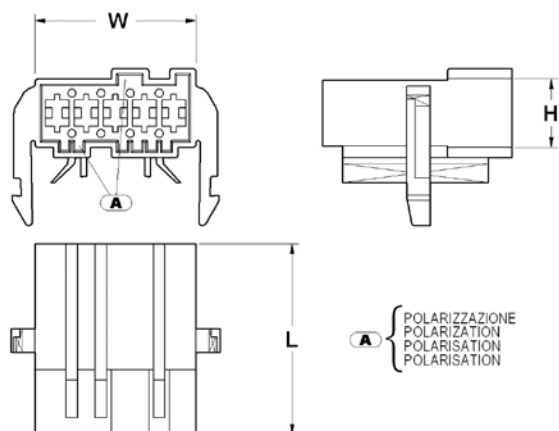

Vie Position	H	L	W	Polarizzazione Polarization	Materiale Material	Articolo N° P.N.	Note
5	11,7	33	27,6		PA 66 V-2	5450342700	
					PA 66 V-0	5550342700	
					PA 66 V-0	6350342700	
					PA 66 V-2	6450342700	

CONNETTORI PORTA MASCHI 6,3 PASSO 5
WIRE CRIMP TABS HOUSINGS 6,3 RAST 5

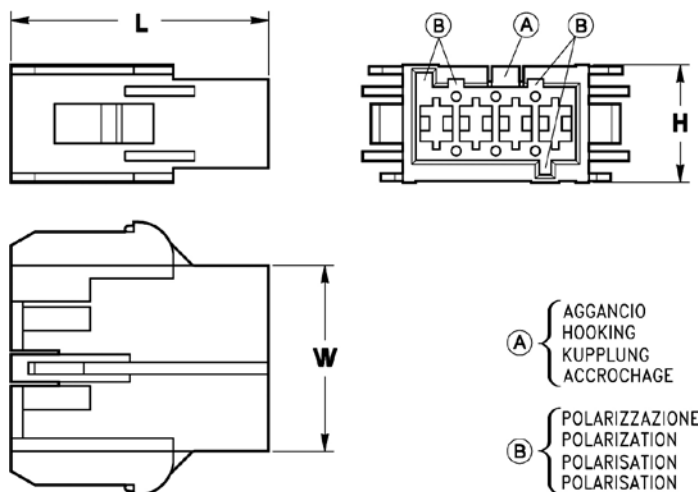

Vie Position	H	L	W	Polarizzazione Polarization	Materiale Material	Articolo N° P.N.	Note
3	13,3	32,5	18,5		PA 66 V-2	0854293700	
					PA 66 V-0	0855293700	
					PA 66 V-0	0863293700	
					PA 66 V-2	0864293700	
4	14,9	32,5	23,5		PA 66 V-2	0854142700	
					PA 66 V-0	0855142700	
					PA 66 V-2	0864142700	

Segue • Follow ➤

Vie Position	H	L	W	Polarizzazione Polarization	Materiale Material	Articolo N° P.N.	Note Notes
4	14,9	32,5	23,5		PA 66 V-2	0854295700	
					PA 66 V-0	0855295700	
					PA 66 V-2	0864295700	
5	13,2	31	27,5		PA 66 V-2	0854088700	
					PA 66 V-0	0855088700	
					PA 66 V-2	0864088700	
8	13,2	30,5	43,5		PA 66 V-2	0854086700	
					PA 66 V-0	0855086700	
					PA 66 V-2	0864086700	
8	13,2	30,5	43,5		PA 66 V-2	0854089700	
					PA 66 V-0	0855089700	
					PA 66 V-2	0864089700	
8	13,2	32,5	43,5		PA 66 V-2	0854135700	
					PA 66 V-0	0855135700	
					PA 66 V-2	0864135700	
8	13,2	32,5	43,5		PA 66 V-2	0854136700	
					PA 66 V-0	0855136700	
					PA 66 V-2	0864136700	
8	13,2	32,5	43,5		PA 66 V-2	0854267700	
					PA 66 V-0	0855267700	
					PA 66 V-2	0864267700	

CONNETTORI PORTA MASCHI 6,3 PASSO 5
WIRE CRIMP TABS HOUSINGS 6,3 RAST 5

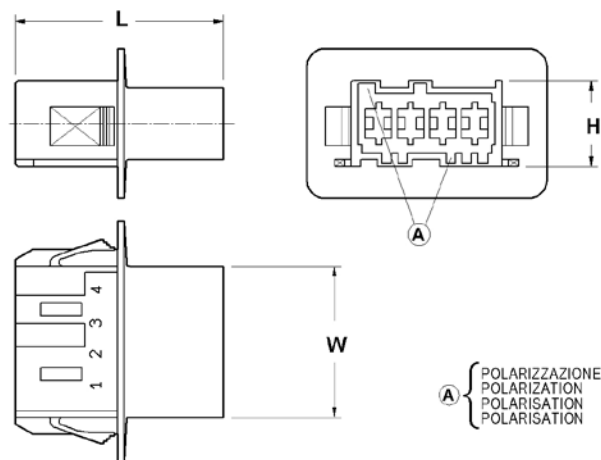

Vie Position	H	L	W	Polarizzazione Polarization	Materiale Material	Articolo N° P.N.	Note Notes
4	13,3	32,5	23,5		PA 66 V-2	5452027700	
					PA 66 V-0	5552027700	
					PA 66 V-2	6452027700	
8	13,3	32,5	43,5		PA 66 V-2	5452028700	
					PA 66 V-0	5552028700	
					PA 66 V-2	6452028700	

CONNETTORI PORTA MASCHI 6,3
PASSO 5 10 VIE
 WIRE CRIMP TABS HOUSINGS 6,3
 RAST 5 10 POSITION

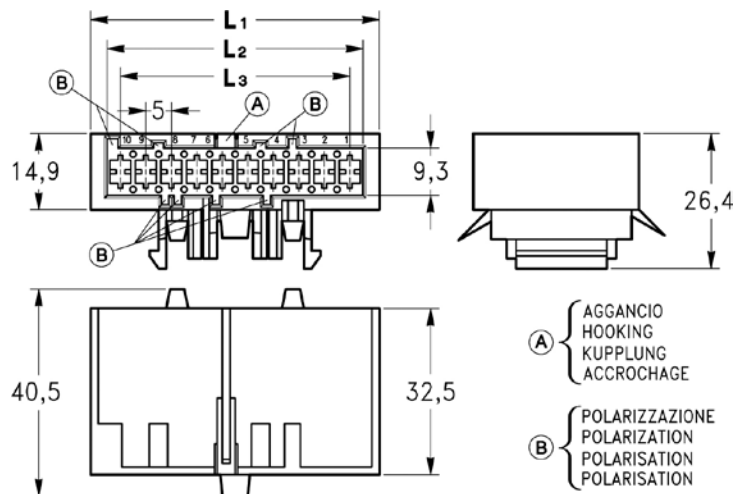

Vie Position	L1	L2	L3	Polarizzazione Polarization	Materiale Material	Articolo N° P.N.	Note Notes
10	53,5	50,2	45		PA 66 V-2	0854137700	
					PA 66 V-0	0855137700	
					PA 66 V-2	0864137700	

CONNETTORI PORTA MASCHI 6,3
PASSO 5 10 VIE PER MOTORI
 WIRE CRIMP TABS HOUSINGS 6,3
 RAST 5 FOR MOTORS

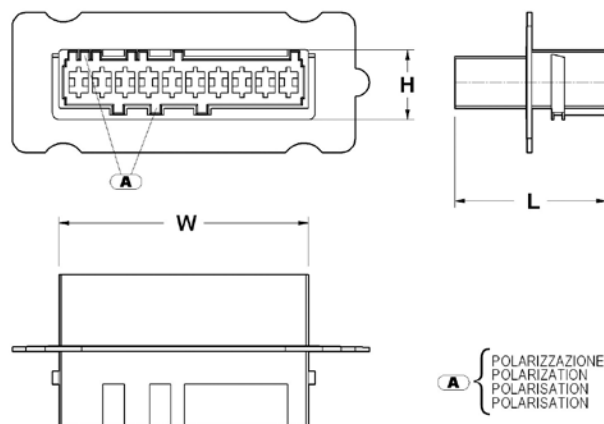

Vie Position	H	L	W	Polarizzazione Polarization	Materiale Material	Articolo N° P.N.	Note Notes
10	14,9	32,5	53,5		PA 66 V-2	5452071700	
					PA 66 V-0	5552071700	
					PA 66 V-2	6452071700	

**CONNETTORI PORTA MASCHI 6,3
PASSO 5 8 VIE ADATTO PER INSERIMENTO
RITENZIONE SECONDARIA**

WIRE CRIMP TABS HOUSINGS 6,3
RAST 5 8 POSITION SUITABLE FOR THE INSERTION
OF A SECONDARY LOCK

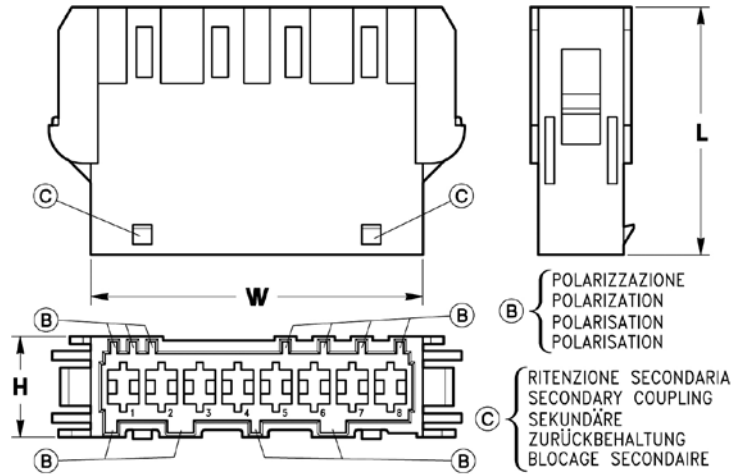

Vie Position	H	L	W	Polarizzazione Polarization	Materiale Material	Articolo N° P.N.	Note Notes
8	13,3	32,5	43,5		PA 66 V-2	0854319700	
					PA 66 V-0	0855319700	
					PA 66 V-2	0864319700	

**CONNETTORI PORTA MASCHI 6,3
PASSO 5 10 VIE ADATTO PER INSERIMENTO
RITENZIONE SECONDARIA**

WIRE CRIMP TABS HOUSINGS 6,3
RAST 5 10 POSITION SUITABLE FOR THE INSERTION
OF A SECONDARY LOCK

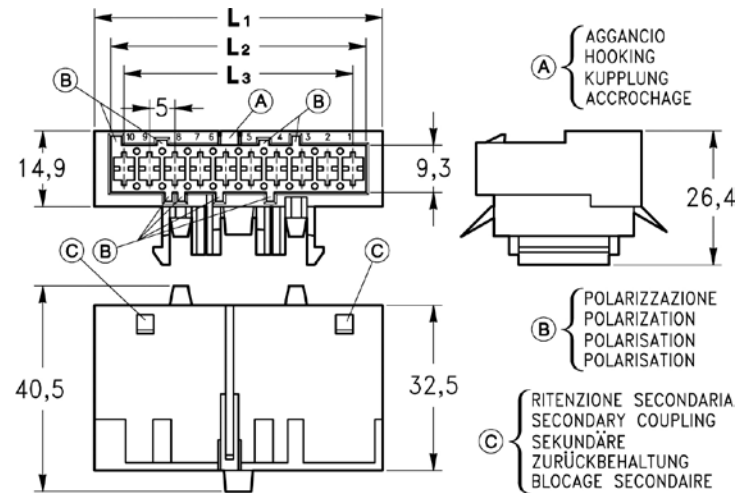

Vie Position	L1	L2	L3	Polarizzazione Polarization	Materiale Material	Articolo N° P.N.	Note Notes
10	53,5	50,2	45		PA 66 V-2	0854320700	
					PA 66 V-0	0855320700	
					PA 66 V-2	0864320700	

**CONNETTORI PORTA MASCHI 6,3
PASSO 5 10 VIE ADATTO PER INSERIMENTO
RITENZIONE SECONDARIA CON PARA ACQUA**
WIRE CRIMP TABS HOUSINGS 6,3
RAST 5 10 POSITION SUITABLE FOR THE INSERTION
OF A SECONDARY LOCK WITH WATER PROTECTION

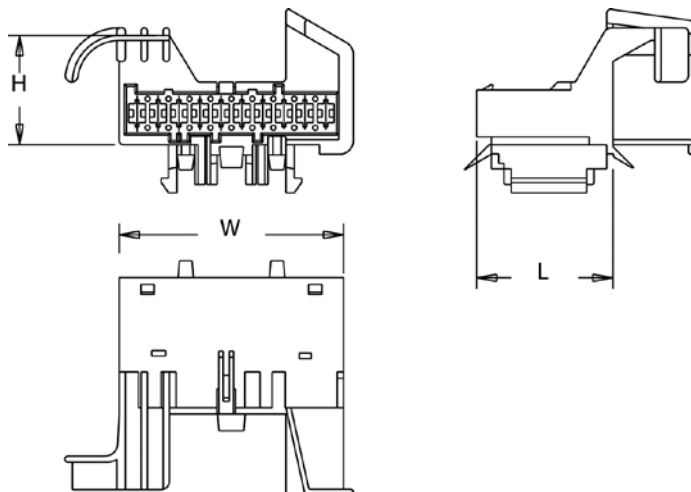

Vie Position	H	L	W	Polarizzazione Polarization	Materiale Material	Articolo N° P.N.	Note Notes
7	26	32,5	38,5		PA 66 V-2	5452067700	
					PA 66 V-0	5552067700	
					PA 66 V-2	6452067700	
10	26	32,5	53,5		PA 66 V-2	5450371700	
					PA 66 V-0	5550371700	
					PA 66 V-2	6450371700	

**PROTEZIONE PER CONNETTORI
PORTA MASCHIO 6,3 PASSO 5 PER MOTORI**
COVER FOR TABS HOUSINGS 6,3
RAST 5 FOR MOTORS

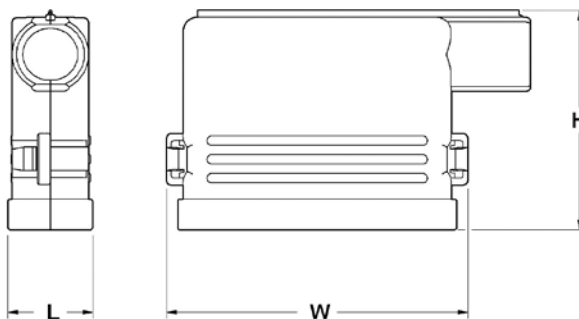

H	L	W	Materiale Material	Articolo N° P.N.	Note Notes
47	18,2	64,5	PP	5252073700	
			PA 66 V-2	5452073700	
			PA 66 V-0	5552073700	

RITENZIONE SECONDARIA

SECONDARY LOCK

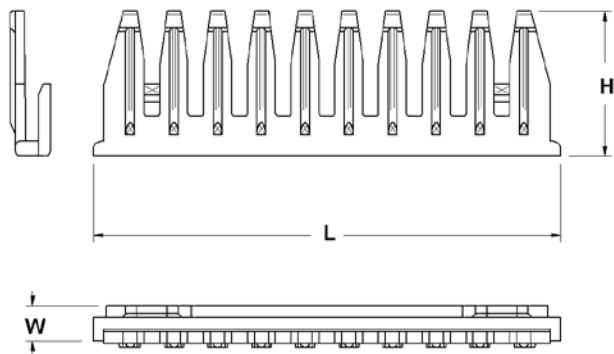

Vie Position	H	L	W	Materiale Material	Articolo N° P.N.	Note Notes
5	16,5	27,5	4	PA 66 V-2	5452079700	
				PA 66 V-0	5552079700	
				PA 66 V-0	6352079700	
10	16,5	53,5	4	PA 66 V-2	0854321700	
				PA 66 V-0	0855321700	
				PA 66 V-2	0864321700	

G1.3

Receptacles

- 061 INAR-TC RAST 5 CRIMP CONNECTOR SYSTEM
- 075 INAR-SAFETY AND INAR-LIF RAST 5 CONNECTOR SYSTEM
- 083 INAR-LIF FLAG-TYPE RAST 5 CONNECTOR SYSTEM

G1.3

INAR-TC RAST 5 CRIMP
connector system

- 063 **INAR-TC TERMINALS**
- 065 **INAR-TC RECEPTACLES HOUSINGS**
- 070 **INSERTIONS FOR POLARIZATION**
- 070 **WIRE CRIMP TABS HOUSINGS FOR TIMER**

PRODOTTI INAR-TC PER CONNESSIONI PASSO 5

La connettorizzazione multipla trova ottima espressione in questi prodotti data la loro affidabilità confermata dal loro ampio uso in ogni settore. INAR-TC. è stato riprogettato ed adattato ai nuovi criteri di automazione del cablaggio, consentendo nuovi margini di profitto grazie alla riduzione dei costi ed al migliore livello di qualità dei moduli finiti. Inarca presenta, in questo prospetto, la linea di connessione a passo 5 già recepita dal settore elettrodomestico, in cui vengono impiegati contatti con portata fino a 16 A. Altre applicazioni, qui non descritte, vengono normalmente offerte.

INAR-TC offre alcuni significativi vantaggi che portano a conseguenti più sicuri profitti:

- Bassissimo carico di accoppiamento con il maschio.
- Elevata portata di corrente.
- Connettore a passo 5 mm.
- Lavorazione con sistemi di connettore automatico.

CARATTERISTICHE TECNICHE

- Campo di applicazione: 0,30÷2,50 mm²
- Portata di corrente fino a: 16 A
- Carico di accoppiamento su terminale: 6,3 × 0,8 DIN 46244 4-6 N
- Tenuta del terminale nel connettore: ≥70 N

CONNETTORI

Sono disponibili connettori da 2 a 12 vie, con o senza polarizzazione. I connettori in plastica INAR-TC sono costruiti con materiali autoestinguenti secondo UL 94 V-2 e V-0 (sono inoltre disponibili materiali plastici autoestinguenti che superano la prova al filo incandescente GWT 750°C senza fiamma).

I connettori indicati sono di color NATURALE. Su richiesta vengono forniti connettori con colorazione codice RAL. Per l'ordinazione sostituire il terzo e il penultimo numero del codice con il numero del colore desiderato.

OMOLOGAZIONI

I prodotti Inarca rispondono alle norme internazionali. Elenchi omologazioni UL e VDE disponibile su richiesta.

Per gli estrattori della Serie INAR-TC, fare riferimento alle "Attrezzature Manuali" della Sezione M.

INAR-TC 5MM PITCH CONNECTION PRODUCTS

Multiple connector applications have good results with these products as they are reliable; this is confirmed by the fact that they are widely used in every sector. The INAR-TC has been redesigned and adapted according to the new wiring automation criteria, which makes it possible to obtain new profit margins thanks to the reduction in costs and to a better level of quality of the finished modules. With this in mind, Inarca presents a 5 pitch connection series, which has already been accepted by the domestic appliances sector, where contacts with a capacity of up to 16 A are used. Other applications which are not described here, are normally offered.

The INAR-TC offer some very significant advantages which consequently result in certain profits:

- Very low male connector load.
- High current capacity.
- 5 mm pitch connector applications.
- The possibility to work with automatic connector system.

TECHNICAL CHARACTERISTICS

- Field of application: 0,30÷2,50 mm²
- Current capacity up to: 16 A
- Connecting load on the terminal: 6,3 × 0,8 DIN 46244 4-6 N
- Terminal seal on the connector: ≥70 N

CONNECTORS

Connectors availability from 2 to 12 ways, step 5 mm, with or without polarization. INAR-TC plastic connectors are made of self extinguishing materials, as required by UL 94 V-2 and V-0 (moreover, plastic auto-extinguish materials are available which can pass the incandescent wire test GWT 750°C no flame).

The connectors indicated are in NATURAL colour. On request we can supply connectors in RAL code colours. To order, please replace the last but two and the last but one code number by the colour number desired.

APPROVAL

Inarca products comply with international regulations. UL and VDE approval lists are available on request.

For the Extractors of INAR-TC Series, please referring to "Hand Tools" in Section M.

INAR-TC TERMINALI AD INSERIMENTO DOLCE

INAR-TC LOW INSERTION TERMINALS

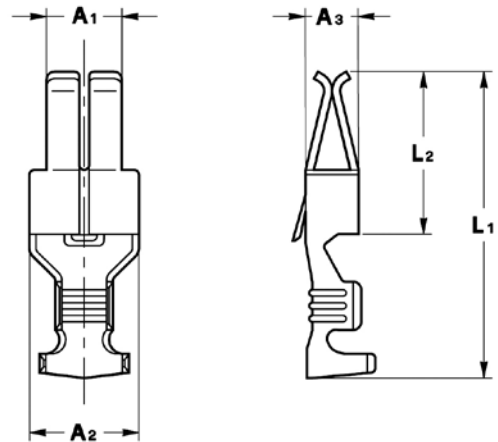

Sez. cavo Wire size (mm ²)	Isolante Insulation (mm)	Dim. maschio Mating tab thk (mm)	Spess. mat. Stock thk (mm)	R	A1	A2	A3	L1	L2	Materiale Material	Finitura Plating material	Articolo N° P.N.	Note Notes
0,5 ÷ 1,5 (AWG 20 ÷ 15)	1,9 ÷ 3,3	0,8	0,32	×	4,7	6,8	3,3	19,2	10,8	CuZn	Pre-Tinned	0011116101	
										CuZn	Silver Plated	0011116301	
										CuSn	Pre-Tinned	0111116101	
										CuSn	Silver Plated	0111116301	
1 ÷ 2,5 (AWG 17 ÷ 13)	2,5 ÷ 4	0,8	0,4	×	4,7	6,8	3,3	19,2	10,9	CuZn	Pre-Tinned	0011213101	
										CuZn	Silver Plated	0011213301	
										CuSn	Pre-Tinned	0111213101	
										CuSn	Silver Plated	0111213301	
										CuNiSiMg	Pre-Tinned	1411213101	

INAR-TC TERMINALI AD INSERIMENTO DOLCE

INAR-TC LOW INSERTION TERMINALS

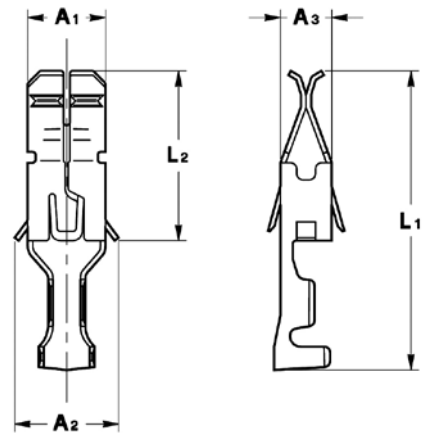

Sez. cavo Wire size (mm ²)	Isolante Insulation (mm)	Dim. maschio Mating tab thk (mm)	Spess. mat. Stock thk (mm)	R	A1	A2	A3	L1	L2	Materiale Material	Finitura Plating material	Articolo N° P.N.	Note Notes
0,3 ÷ 0,75 (AWG 22 ÷ 18)	1,7 ÷ 2,2	0,8	0,32	x	5	6,8	3,3	19,2	10,9	CuZn	Pre-Tinned	0011334101	
										CuZn	Silver Plated	0011334301	
										CuSn	Pre-Tinned	0111334101	
										CuSn	Silver Plated	0111334301	
										CuNiZn		0911334001	
										CuFe 2P	Pre-Tinned	1011334101	
										CuFe 2P	Silver Plated	1011334301	

INAR-TC TERMINALI AD INSERIMENTO DOLCE

INAR-TC LOW INSERTION TERMINALS

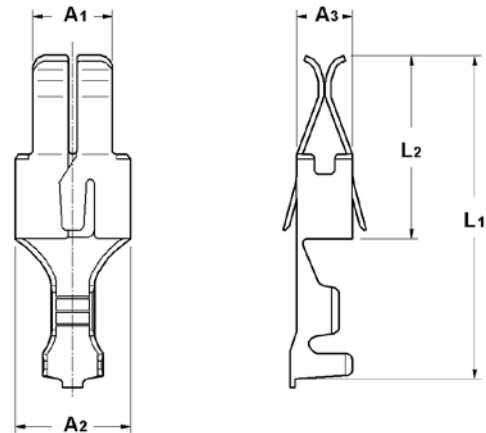

Sez. cavo Wire size (mm ²)	Isolante Insulation (mm)	Dim. maschio Mating tab thk (mm)	Spess. mat. Stock thk (mm)	R	A1	A2	A3	L1	L2	Materiale Material	Finitura Plating material	Articolo N° P.N.	Note Notes
0,3 ÷ 0,75 (AWG 22 ÷ 18)	1,7 ÷ 2,2	0,8	0,32	x	4,7	6,8	3,3	19,1	10,8	CuZn	Pre-Tinned	0011500101	
										CuSn	Pre-Tinned	0111500101	
										CuNiSiMg	Pre-Tinned	1411500101	
0,5 ÷ 1,5 (AWG 20 ÷ 15)	1,9 ÷ 3,3	0,8	0,32	x	4,7	6,8	3,3	19,2	10,8	CuZn	Pre-Tinned	0011501101	[C]
										CuSn	Pre-Tinned	0111501101	
										CuNiSiMg	Pre-Tinned	1411501101	

Segue • Follow ➤

Sez. cavo Wire size (mm ²)	Isolante Insulation (mm)	Dim. maschio Mating tab thk (mm)	Spess. mat. Stock thk (mm)	R	A1	A2	A3	L1	L2	Materiale Material	Finitura Plating material	Articolo N° P.N.	Note Notes
1 ÷ 2,5 (AWG 17 ÷ 13)	2,5 ÷ 4	0,8	0,32	x	4,7	6,8	3,3	19,1	10,8	CuZn	Pre-Tinned	0011502101	[B]
										CuSn	Pre-Tinned	0111502101	
										CuNiSiMg	Pre-Tinned	1411502101	

[B] Sezione cavo: 1+1- ø Isolante: 2,5 + 2,5

[C] Sezione cavo 0,5+0,5 ø Isolante 1,9+1,9

[B] Wire Range: 1+1- ø Insulation: 2,5 + 2,5

[C] Wire range 0,5+0,5 ø Insulation 1,9+1,9

INAR-TC CONNETTORI MASCHIO RAST 5 SENZA POLARIZZAZIONE

INAR-TC RECEPTACLES HOUSINGS RAST 5 WITHOUT POLARIZATION

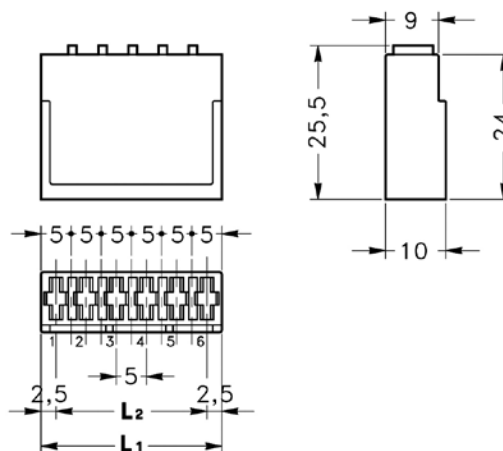

Vie Position	L1	L2	Polarizzazione Polarization	Materiale Material	Articolo N° P.N.	Note Notes
3	15	10	<div style="border: 1px solid black; display: inline-block; padding: 2px;">1 2 3</div>	PA 66 V-2	0854172700	
				PA 66 V-0	0855172700	
				PA 66 V-2	0864172700	
5	25	20	<div style="border: 1px solid black; display: inline-block; padding: 2px;">1 2 3 4 5</div>	PA 66 V-2	0854174700	
				PA 66 V-0	0855174700	
				PA 66 V-2	0864174700	
6	30	25	<div style="border: 1px solid black; display: inline-block; padding: 2px;">1 2 3 4 5 6</div>	PA 66 V-2	0854175700	
				PA 66 V-0	0855175700	
				PA 66 V-2	0864175700	

INAR-TC CONNETTORI MASCHIO RAST 5
INAR-TC RECEPTACLES HOUSINGS RAST 5

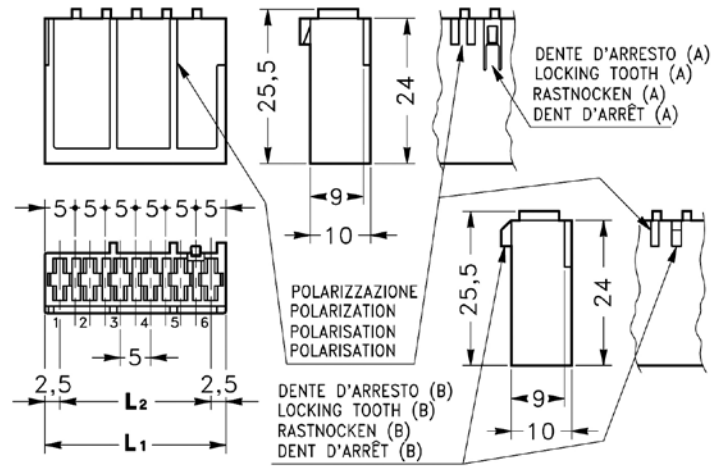





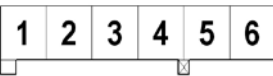
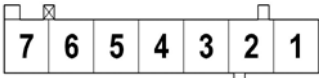

Vie Position	L1	L2	Dentearresto Toothstop	Polarizzazione Polarization	Materiale Material	Articolo N° P.N.	Note Notes
2	10	5	(A)		PA 66 V-2	0854171700	
					PA 66 V-0	0855171700	
					PA 66 V-2	0864171700	
2	10	5	(A)		PA 66 V-2	0854258700	
					PA 66 V-0	0855258700	
					PA 66 V-2	0864258700	
2	10	5	(A)		PA 66 V-2	0854259700	
					PA 66 V-0	0855259700	
					PA 66 V-2	0864259700	
2	10	5	(A)		PA 66 V-2	5450386700	
					PA 66 V-0	5550386700	
					PA 66 V-2	6450386700	
2	10	5	(A)		PA 66 V-2	5452021700	
					PA 66 V-0	5552021700	
					PA 66 V-2	6452021700	
3	15	10	(A)(B)		PA 66 V-2	5452065700	
					PA 66 V-0	5552065700	
					PA 66 V-2	6452065700	
3	15	10	(A)		PA 66 V-2	0854180700	
					PA 66 V-0	0855180700	
					PA 66 V-2	0864180700	
3	15	10	(A)		PA 66 V-2	0854226700	
					PA 66 V-0	0855226700	
					PA 66 V-2	0864226700	
3	15	10	(A)		PA 66 V-2	0854243700	
					PA 66 V-0	0855243700	
					PA 66 V-2	0864243700	
3	15	10	(A)		PA 66 V-2	0854265700	
					PA 66 V-0	0855265700	
					PA 66 V-2	0864265700	

Segue • Follow ➤

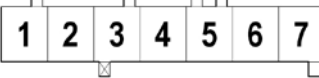
Vie Position	L1	L2	Dentearresto Toothstop	Polarizzazione Polarization	Material	Articolo N° P.N.	Note
3	15	10	(A)		PA 66 V-2	5450387700	
					PA 66 V-0	5550387700	
					PA 66 V-2	6450387700	
4	20	15	(A)		PA 66 V-2	0854173700	
					PA 66 V-0	0855173700	
					PA 66 V-2	0864173700	
4	20	15	(A)		PA 66 V-2	5452074700	
					PA 66 V-0	5552074700	
					PA 66 V-2	6452074700	
4	20	15	(A)		PA 66 V-2	0854323700	
					PA 66 V-0	0855323700	
					PA 66 V-2	0864323700	
4	20	15	(B)		PA 66 V-2	0854297700	
					PA 66 V-0	0855297700	
					PA 66 V-2	0864297700	
4	20	15	(B)		PA 66 V-2	5450362700	
					PA 66 V-0	5550362700	
					PA 66 V-2	6450362700	
4	20	15	(A)		PA 66 V-2	5450388700	
					PA 66 V-0	5550388700	
					PA 66 V-2	6450388700	
4	25	20	(A)		PA 66 V-2	0854279700	
					PA 66 V-0	0855279700	
					PA 66 V-2	0864279700	
5	25	20	(A)		PA 66 V-2	0854176700	
					PA 66 V-0	0855176700	
					PA 66 V-2	0864176700	
5	25	20	(A)		PA 66 V-2	0854260700	
					PA 66 V-0	0855260700	
					PA 66 V-2	0864260700	
6	30	25	(A)		PA 66 V-2	0854261700	
					PA 66 V-0	0855261700	
					PA 66 V-2	0864261700	
6	30	25	(A)		PA 66 V-2	0854264700	
					PA 66 V-0	0855264700	
					PA 66 V-2	0864264700	
6	30	25	(A)		PA 66 V-2	0854284700	
					PA 66 V-0	0855284700	
					PA 66 V-2	0864284700	
6	30	25	(A)		PA 66 V-2	0854290700	
					PA 66 V-0	0855290700	
					PA 66 V-2	0864290700	
6	30	25	(A)		PA 66 V-2	0854312700	
					PA 66 V-0	0855312700	
					PA 66 V-2	0864312700	

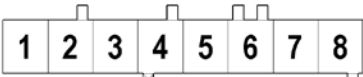
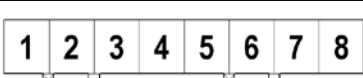
Segue • Follow ➤

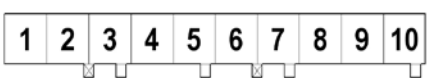
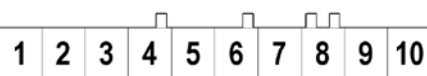
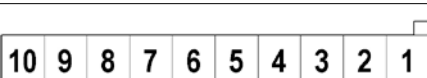
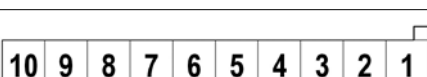
Vie Position	L1	L2	Dentearresto Toothstop	Polarizzazione Polarization	Materiale Material	Articolo N° P.N.	Note Notes
6	30	25	(A)		PA 66 V-2	5452015700	
					PA 66 V-0	5552015700	
					PA 66 V-2	6452015700	
6	30	25	(B)		PA 66 V-2	5450351700	
					PA 66 V-0	5550351700	
					PA 66 V-2	6450351700	
7	35	30	(A)		PA 66 V-2	5452064700	
					PA 66 V-0	5552064700	
					PA 66 V-2	6452064700	
7	35	30	(A)(B)		PA 66 V-2	0854049700	
					PA 66 V-0	0855049700	
					PA 66 V-2	0864049700	
7	35	30	(B)		PA 66 V-2	0854189700	
					PA 66 V-0	0855189700	
					PA 66 V-2	0864189700	
8	40	35	(B)		PA 66 V-2	0854134700	
					PA 66 V-0	0855134700	
					PA 66 V-2	0864134700	
8	40	35	(B)		PA 66 V-2	0854254700	
					PA 66 V-0	0855254700	
					PA 66 V-2	0864254700	
8	40	35	(A)		PA 66 V-2	0854262700	
					PA 66 V-0	0855262700	
					PA 66 V-2	0864262700	
9	45	40	(A)		PA 66 V-2	0854177700	
					PA 66 V-0	0855177700	
					PA 66 V-2	0864177700	
10	50	45	(A)		PA 66 V-2	0854178700	
					PA 66 V-0	0855178700	
					PA 66 V-2	0864178700	
10	50	45	(B)		PA 66 V-2	0854263700	
					PA 66 V-0	0855263700	
					PA 66 V-2	0864263700	
10	50	45	(B)		PA 66 V-2	5450363700	
					PA 66 V-0	5550363700	
					PA 66 V-2	6450363700	
10	50	45	(B)		PA 66 V-2	5452077700	
					PA 66 V-0	5552077700	
					PA 66 V-2	6452077700	

INAR-TC CONNETTORI MASCHIO PER RELÉ
INAR-TC RECEPTACLES HOUSINGS FOR RELAY

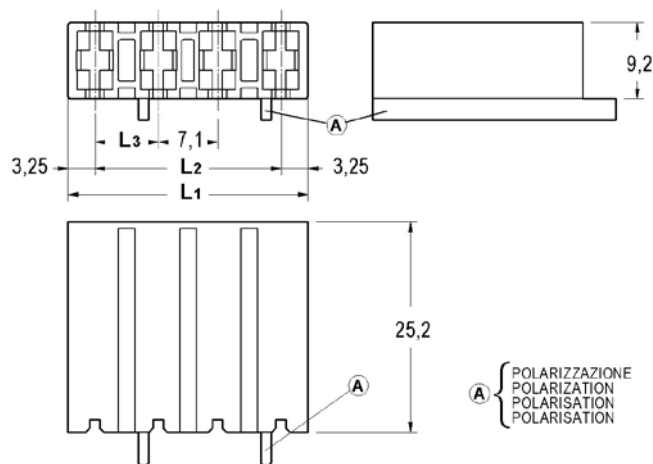

Vie Position	L1	L2	L3	Polarizzazione Polarization	Materiale Material	Articolo N° P.N.	Note Notes
2	14,1	7,6	7,6		PA 66 V-2	5452011700	
					PA 66 V-0	5552011700	
					PA 66 V-2	6452011700	
4	28,8	22,3	7,6		PA 66 V-2	5452012700	
					PA 66 V-0	5552012700	
					PA 66 V-2	6452012700	

**INAR-TC CONNETTORI MASCHIO
 PER COMMUTATORE DREEFS**
**INAR-TC RECEPTACLES HOUSINGS
 FOR DREEFS SWITCH**

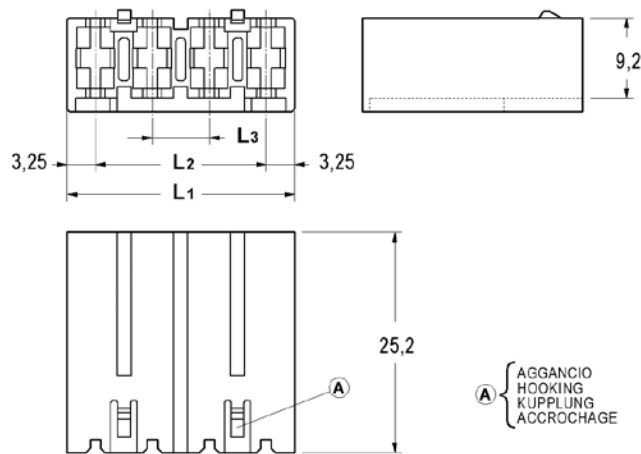

Vie Position	L1	L2	L3	Polarizzazione Polarization	Materiale Material	Articolo N° P.N.	Note Notes
4	26	19,5	6,5		PA 66 V-2	5452013700	
					PA 66 V-0	5552013700	
					PA 66 V-2	6452013700	

INSERTI DI POLARIZZAZIONE
INSERTIONS FOR POLARIZATION

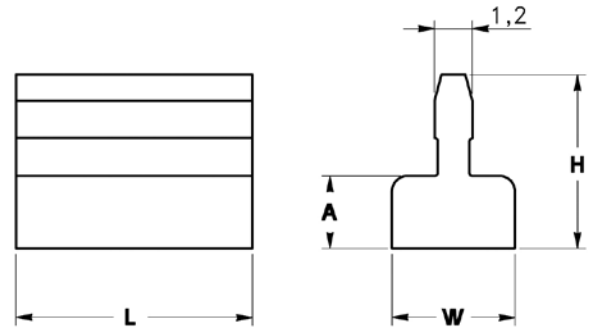

H	A	L	W	Materiale Material	Articolo N° P.N.	Note Notes
5,5	2.3	7,5	3,9	PA 66 V-2	0854195700	
				PA 66 V-0	0855195700	
				PA 66 V-2	0864195700	
4,7	1.5	6,8	3,8	PA 66 V-2	0854210700	
				PA 66 V-0	0855210700	
				PA 66 V-2	0864210700	

CONNETTORI PER TIMER COPRECI 10 VIE
WIRE CRIMP TABS HOUSINGS FOR TIMER COPRECI
10 POSITION

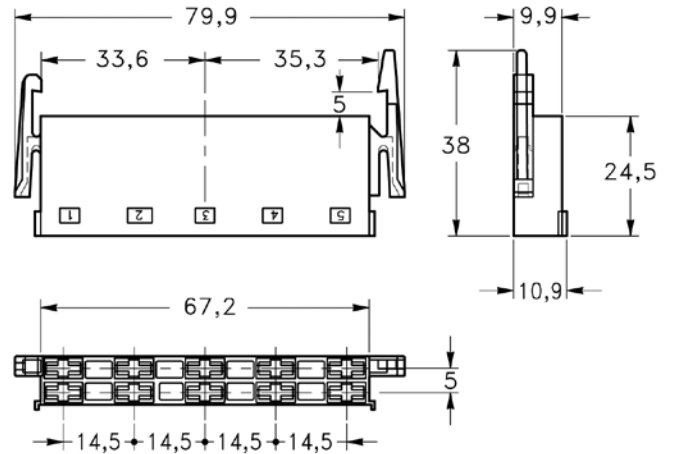

Materiale Material	Articolo N° P.N.	Note Notes
PA 66 V-2	0854292700	
PA 66 V-0	0855292700	
PA 66 V-2	0864292700	

**CONNETTORI PER TIMER ELBI
10 VIE SENZA POLARIZZAZIONE**

WIRE CRIMP TABS HOUSINGS FOR TIMER ELBI
10 POSITION WITHOUT POLARIZATION

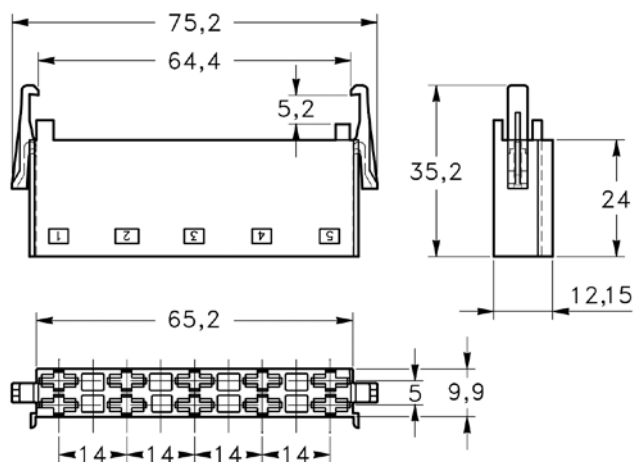

Materiale Material	Articolo N° P.N.	Note Notes
PA 66 V-2	0854257700	
PA 66 V-0	0855257700	
PA 66 V-2	0864257700	

**CONNETTORI PER TIMER ELBI
10 VIE CON POLARIZZAZIONE**

WIRE CRIMP TABS HOUSINGS FOR TIMER ELBI
10 POSITION WITH POLARIZATION

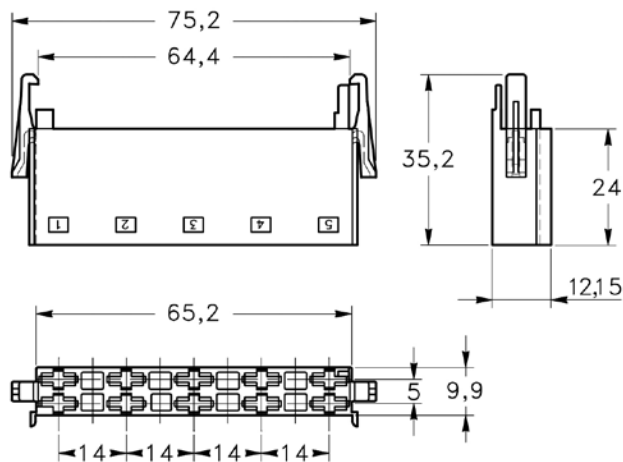

Materiale Material	Articolo N° P.N.	Note Notes
PA 66 V-2	0854280700	
PA 66 V-0	0855280700	
PA 66 V-2	0864280700	

CONNETTORI PER TIMER CROUZET 12 VIE
 WIRE CRIMP TABS HOUSINGS FOR TIMER CROUZET
 12 POSITION

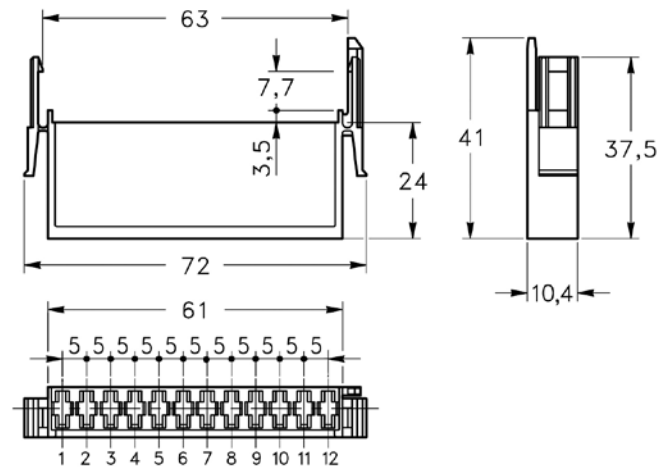

Materiale Material	Articolo N° P.N.	Note Notes
PA 66 V-2	0854170700	
PA 66 V-0	0855170700	
PA 66 V-2	0864170700	

CONNETTORI PER TIMER EATON 12 VIE
 WIRE CRIMP TABS HOUSINGS FOR TIMER EATON
 12 POSITION

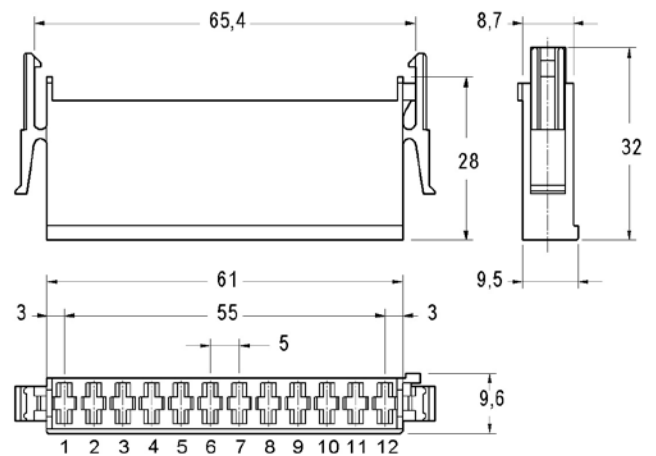

Materiale Material	Articolo N° P.N.	Note Notes
PA 66 V-2	0854227700	
PA 66 V-0	0855227700	
PA 66 V-2	0864227700	

CONNETTORI PER TIMER EATON 12 VIE
 WIRE CRIMP TABS HOUSINGS FOR TIMER EATON
 12 POSITION

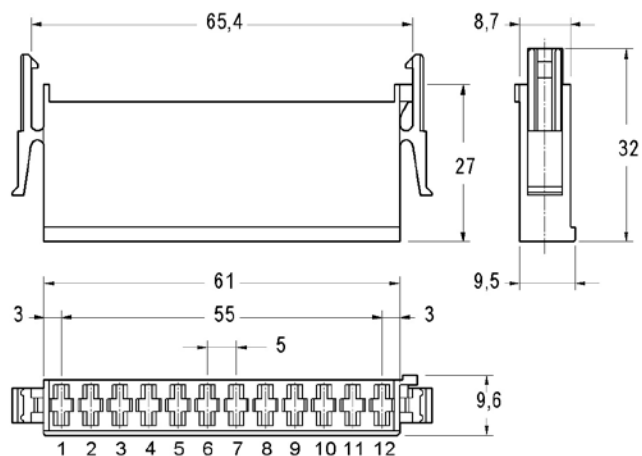

Materiale Material	Articolo N° P.N.	Note Notes
PA 66 V-2	0854306700	
PA 66 V-0	0855306700	
PA 66 V-2	0864306700	

**CONNETTORI PER TIMER EATON 12 VIE PER
 RITENZIONE SECONDARIA**
 WIRE CRIMP TABS HOUSINGS FOR TIMER EATON
 12 POSITION FOR SECONDARY LOCK

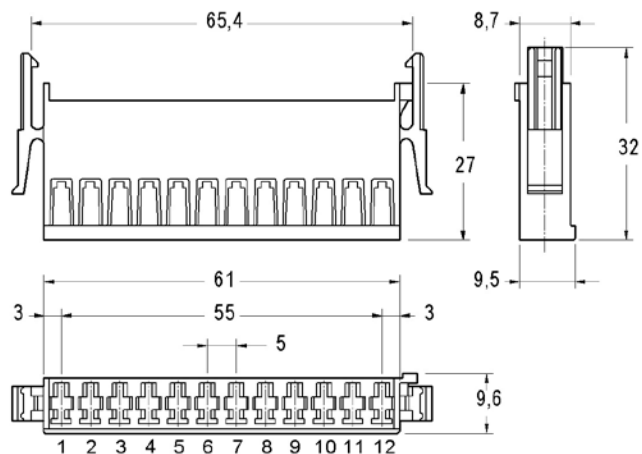

Materiale Material	Articolo N° P.N.	Note Notes
PA 66 V-2	5450381700	
PA 66 V-0	5550381700	
PA 66 V-2	6450381700	

G1.3

INAR-SAFETY and INAR-LIF RAST 5 connector system

- 078 **INAR-SAFETY TYPE (A) STRAIGHT RECEPTACLES 6,3**
- 079 **INAR-LIF TYPE (A) STRAIGHT RECEPTACLES 6,3**
- 080 **RECEPTACLES HOUSINGS 6,3 RAST 5**

PRODOTTI PER CONNESSIONI DI SICUREZZA

La caratteristica è quella di restare fermamente vincolato al terminale maschio, anche in presenza di vibrazioni oppure tirando il filo di collegamento. Un meccanismo di bloccaggio assicura la più alta resistenza allo sfilamento registrabile tra i terminali di questo tipo. La sconnessione è invece molto agevole se si trazona la capsula isolante, e non il filo, nel senso opposto a quello di accoppiamento. Il prodotto offre alcuni importanti vantaggi rispetto alle tradizionali connessioni:

- Elevata portata di corrente.
- Eliminazione di interruzioni accidentali della connessione.
- Connessione sicura anche in presenza di vibrazioni.
- Basso sforzo di connessione.
- Connettorizzazione modulare a passo 5 per il suo ingombro ridotto.

Caratteristiche tecniche

- Campo di applicazione 0,25 ÷ 6,00 mm²
- Portata di corrente fino a 25 A
- Resistenza disaccoppiamento (in assenza di vibrazioni) > 100 N
- Forza di ritenzione del terminale nel connettore fino a 80 N

TERMINALI AD INSERIMENTO DOLCE INAR-LIF

La linea di prodotti INAR-LIF offre al suo utilizzatore, oltre ai vantaggi della consolidata linea Inarca di terminali femmina per connessioni lamellari, il pregio ulteriore di un basso carico di accoppiamento della connessione maschio-femmina. Grazie alla particolare forma dei prodotti INAR-LIF è possibile ottenere fino al 45% di sforzo in meno per realizzare l'inserimento. In tal modo si agevola l'operazione di connessione, si evitano possibili e pericolose deformazioni e si migliora la qualità degli assemblaggi. I prodotti sono infatti stati progettati per dividere in due tempi il lavoro di inserimento: nella prima fase si ottiene una resistenza all'inserimento bassissima che aumenterà solo nella seconda fase a garanzia di una elevata forza di disinserzione dell'accoppiamento ottenuto. I prodotti INAR-LIF non necessitano di alcun investimento per la loro introduzione perchè si applicano con le stesse attrezzature dei terminali tradizionali.

Caratteristiche del prodotto

- Basso carico di inserimento.
- Disponibile in versione "diritta" e "bandiera".
- Nella versione "bandiera" ingombri ridotti ed aggraffatura delle alette del conduttore ad "F".
- Elevata portata di corrente.
- Utilizzo con capsule isolanti standard Inarca.

SAFETY CONNECTIONS

Its characteristic is that of remaining closely bound to the terminal, even if there are vibrations, or if the connection wire is pulled. A blocking mechanism assures high resistance against extraction registered between the terminals of this type. Disconnection is easy if the insulating capsule, not the wire, is tugged in the opposite direction to the connection. Product offers some important advantages with respect to traditional connections:

- High current capacity.
- Elimination of accidental connection interruptions.
- Safe connection if there are vibrations.
- Low connection stress.
- Modular 5 pitch connector applications due to its reduced overall dimensions.

Technical characteristics

- Field of application 0,25 ÷ 6,00 mm²
- Current capacity up to 25 A
- Disconnection resistance (when there are no vibrations) > 100 N
- Receptacle retention force in the connector up to 80 N

INAR-LIF LOW INSERTION TERMINALS

In addition to the advantages provided by the consolidated Inarca line of female connectors for lamellar connections, the INAR-LIF line of products also offers its users the added attractions of its low male/female connection forces. Thanks to their special shape, the INAR-LIF products permit a reduction in the connection force required of up to 45%. This makes all connections faster and easier, precludes the risk of dangerous deformations, and improves the overall quality of the assemblies. These products have been designed to divide the connections process into two phases, characterized by the extremely low insertion force required at the outset and the increase to the elevated force required for the subsequent disconnection of the connection made. INAR-LIF products do not require any investments for their introduction in the system because they can be applied with the same equipment used for traditional terminals.

Product characteristics

- Low connection force.
- Available in "straight" and "flag" versions.
- "Flag" versions with reduced size and "F"-shaped crimping of the cable wings.
- High current load capacity.
- Utilizable with standard Inarca insulating caps.

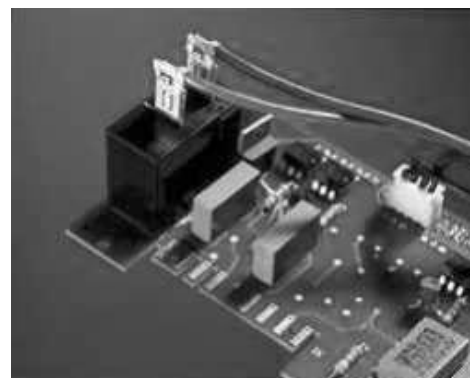
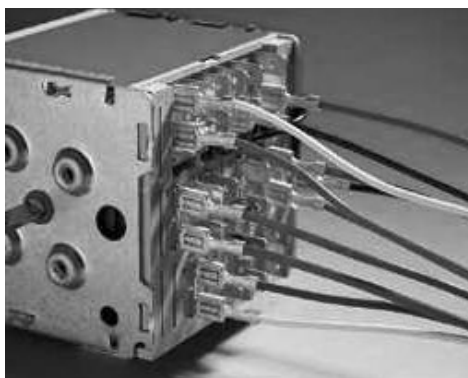

CONNETTORI

Sono disponibili connettori a passo 5 mm, con o senza polarizzazione. I connettori in plastica sono costruiti con materiali autoestinguenti secondo UL 94 V-2 e V-0 (sono inoltre disponibili materiali plastici autoestinguenti che superano la prova al filo incandescente GWT 750°C senza fiamma).

I connettori indicati sono di color NATURALE. Su richiesta vengono forniti connettori con colorazione codice RAL. Per l'ordinazione sostituire il terzultimo e il penultimo numero del codice con il numero del colore desiderato.

OMOLOGAZIONI

I prodotti Inarca rispondono alle norme internazionali. Elenchi omologazioni UL e VDE disponibile su richiesta.

MATERIALI

(vedi pagina 020)

TRATTAMENTI SUPERFICIALI

(vedi pagina 021)

CODICE COLORE

(vedi pagina 026)

CONFEZIONI

Le confezioni sono disponibili nel sito www.inarca.it

CONNECTORS

Connectors availability step 5 mm, with or without polarization. Plastic connectors are made of self extinguishing materials, as required by UL 94 V-2 and V-0 (moreover, plastic auto-extinguish materials are available which can pass the incandescent wire test GWT 750°C no flame).

The connectors indicated are in NATURAL colour. On request we can supply connectors in RAL code colours. To order, please replace the last but two and the last but one code number by the colour number desired.

APPROVAL

Inarca products comply with international regulations. UL and VDE approval lists are available on request.

MATERIALS

(see page 020)

SURFACE TREATMENTS

(see page 021)

COLOUR CODE

(see page 026)

PACKAGE QUANTITY

Packagings are available at the website www.inarca.it

INAR-SAFETY TIPO (A) TERMINALI FEMMINA
DIRITTI ANTI SFILAMENTO 6,3
 INAR-SAFETY TYPE (A) STRAIGHT RECEPTACLES 6,3

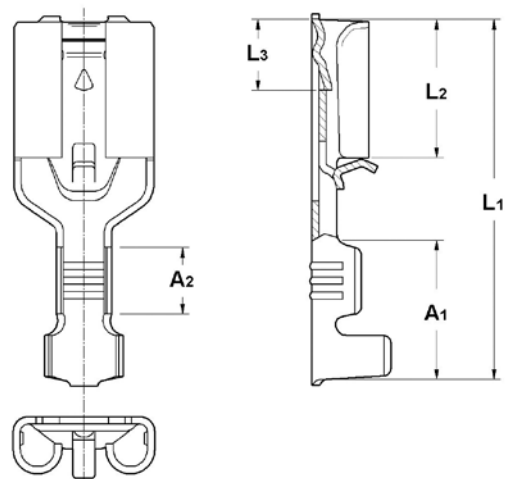

Sez. cavo Wire size (mm ²) (AWG 22 ÷ 17)	Isolante Insulation (mm)	Dim. maschio Mating tab thk (mm)	Spess. mat. Stock thk (mm)	A1	A2	L1	L2	L3	LI	Materiale Material	Finitura Plating material	Articolo N° P.N.	Note Notes
0,325 ÷ 1 (AWG 22 ÷ 17)	1,7 ÷ 2,5	0,8	0,4	7,1	3,6	19,5	7,5	3,9	x	CuZn		0011496001	
										CuZn	Pre-Tinned	0011496101	
										CuZn	Tin Plated	0011496201	
										CuSn		0111496001	
										CuSn	Pre-Tinned	0111496101	
										CuNiZn		0911496001	
0,5 ÷ 1,5 (AWG 20 ÷ 15)	1,9 ÷ 3,3	0,8	0,4	7,1	3,6	19,5	7,5	3,9	x	CuZn		0011365001	
										CuZn	Pre-Tinned	0011365101	
										CuZn	Tin Plated	0011365201	
										CuSn		0111365001	
										CuSn	Pre-Tinned	0111365101	
										CuNiZn		0911365001	
1 ÷ 2,5 (AWG 17 ÷ 13)	2,5 ÷ 4	0,8	0,4	7,3	3,9	19,5	7,5	3,9	x	CuZn		0011364001	[B]
										CuZn	Pre-Tinned	0011364101	
										CuZn	Tin Plated	0011364201	
										CuSn		0111364001	
										CuSn	Pre-Tinned	0111364101	
										CuNiZn		0911364001	

[B] Sezione cavo: 1+1- ø Isolante: 2,5 + 2,5

[B] Wire Range: 1+1- ø Insulation: 2,5 + 2,5

INAR-LIF TIPO (A) TERMINALI FEMMINA
DIRITTI INSERIMENTO DOLCE 6,3
INAR-LIF TYPE (A) STRAIGHT RECEPTACLES 6,3

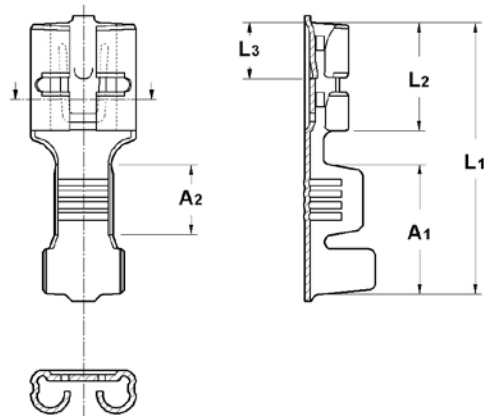

Sez. cavo Wire size (mm ²)	Isolante Insulation (mm)	Dim. maschio Mating tab thk (mm)	Spess. mat. Stock thk (mm)	A1	A2	L1	L2	L3	LI	Materiale Material	Finitura Plating material	Articolo N° P.N.	Note Notes
0,3 ÷ 1 (AWG 22 ÷ 17)	1,7 ÷ 2,5	0,8	0,4	8,5	4,3	19,3	7,7	4	x	CuZn		0011602001	
										CuZn	Tin Plated	0011602201	
										CuZn	Silver Plated	0011602301	
										Fe	Ni	0211602121	
										CuNiZn		0911602001	
0,5 ÷ 1,5 (AWG 20 ÷ 15)	1,9 ÷ 3,3	0,8	0,4	8,3	4,5	19,3	7,7	4	x	CuZn		0011348001	
										CuZn	Tin Plated	0011348201	
										CuZn	Silver Plated	0011348301	
										Fe	Ni	0211348121	
										CuNiZn		0911348001	
0,5 ÷ 1,5 (AWG 20 ÷ 15)	1,9 ÷ 3,3	0,8	0,4	8,3	4,5	19,3	7,7	4	x	CuZn		0011636001	[U]
										CuZn	Tin Plated	0011636201	
										CuZn	Silver Plated	0011636301	
										CuNiZn		0911636001	
1,0 ÷ 2,5 (AWG 17 ÷ 13)	2,5 ÷ 4	0,8	0,4	9,2	5	19,3	7,7	4	x	CuZn		0011322001	
										CuZn	Tin Plated	0011322201	
										CuZn	Silver Plated	0011322301	
										Fe	Ni	0211322121	
										CuNiZn		0911322001	
3 ÷ 6 (AWG 12 ÷ 9)	4,2 ÷ 5,1	0,8	0,4	9,2	4,9	19,3	7,7	4	x	CuZn		0011349001	
										CuZn	Tin Plated	0011349201	
										CuZn	Silver Plated	0011349301	
										Fe	Ni	0211349121	
										CuNiZn		0911349001	

[U] Senza bugna

[U] Without indentation

**CONNETTORI PER TERMINALI
FEMMINA DIRITTI 6,3 RAST 5**
RECEPTACLES HOUSINGS 6,3 RAST 5

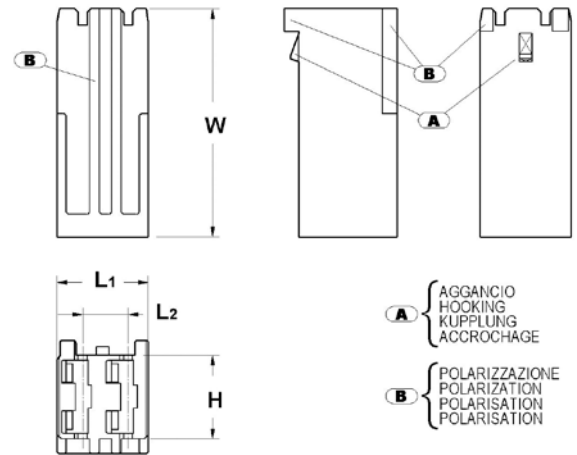

Vie Position	H	L1	L2	W	Polarizzazione Polarization	Materiale Material	Articolo N° P.N.	Note Notes
2	9,2	10	5	25		PA 66 V-2	0854314700	
						PA 66 V-0	0855314700	
						PA 66 V-0	0863314700	
2	9,2	10	5	25		PA 66 V-2	0854328700	
						PA 66 V-0	0855328700	
						PA 66 V-0	0863328700	
2	9,2	10	5	25		PA 66 V-2	0854329700	
						PA 66 V-0	0855329700	
						PA 66 V-2	0864329700	
2	9,2	10	5	25		PA 66 V-2	5452029700	
						PA 66 V-0	5552029700	
						PA 66 V-2	6452029700	
2	9,2	10	5	25		PA 66 V-2	5452030700	
						PA 66 V-0	5552030700	
						PA 66 V-2	6452030700	
						PA 66 V-2	6452030710	
2	9,2	10	5	25		PA 66 V-2	5452031700	
						PA 66 V-0	5552031700	
						PA 66 V-2	6452031700	
2	9,2	10	5	25		PA 66 V-2	5452032700	
						PA 66 V-0	5552032700	
						PA 66 V-2	6452032700	
2	9,2	10	5	25		PA 66 V-2	5452075700	
						PA 66 V-0	5552075700	
						PA 66 V-2	6452075700	
3	9,2	14,9	10	25		PA 66 V-2	0854315700	
						PA 66 V-0	0855315700	
						PA 66 V-2	0864315700	
3	9,2	14,9	10	25		PA 66 V-2	0854340700	
						PA 66 V-0	0855340700	
						PA 66 V-0	0863340700	

Segue • Follow ➤

Vie Position	H	L1	L2	W	Polarizzazione Polarization	Materiale Material	Articolo N° P.N.	Note Notes
4	9,2	20	15	25		PA 66 V-2	0854316700	
						PA 66 V-0	0855316700	
						PA 66 V-2	0864316700	
5	9,2	25	20	25		PA 66 V-2	0854317700	
						PA 66 V-0	0855317700	
						PA 66 V-2	0864317700	
6	9,2	30	25	25		PA 66 V-2	0854318700	
						PA 66 V-0	0855318700	
						PA 66 V-2	0864318700	
6	9,2	29,7	25	25		PA 66 V-2	5452072700	
						PA 66 V-0	5552072700	
						PA 66 V-2	6452072700	

G1.3

INAR-LIF flag-type
RAST 5 connector system

- 086 **INAR-LIF FLAG TYPE RECEPTACLES 6,3**
- 088 **INAR-LIF CONNECTORS
FOR FLAG TYPE RECEPTACLES 6,3 RAST 5**

TERMINALI AD INSERIMENTO DOLCE INAR-LIF

La linea di prodotti INAR-LIF offre al suo utilizzatore, oltre ai vantaggi della consolidata linea Inarca di terminali femmina per connessioni lamellari, il pregio ulteriore di un basso carico di accoppiamento della connessione maschio-femmina. Grazie alla particolare forma dei prodotti INAR-LIF è possibile ottenere fino al 45% di sforzo in meno per realizzare l'inserimento. In tal modo si agevola l'operazione di connessione, si evitano possibili e pericolose deformazioni e si migliora la qualità degli assemblaggi. I prodotti sono infatti stati progettati per dividere in due tempi il lavoro di inserimento: nella prima fase si ottiene una resistenza all'inserimento bassissima che aumenterà solo nella seconda fase a garanzia di una elevata forza di disinserzione dell'accoppiamento ottenuto. I prodotti INAR-LIF non necessitano di alcun investimento per la loro introduzione perchè si applicano con le stesse attrezzature dei terminali tradizionali.

Caratteristiche del prodotto

- Basso carico di inserimento.
- Disponibile in versione "diritta" e "bandiera".
- Nella versione "bandiera" ingombri ridotti ed aggraffatura delle alette del conduttore ad "F".
- Elevata portata di corrente.
- Utilizzo con capsule isolanti standard Inarca.

OMOLOGAZIONI

I prodotti Inarca rispondono alle norme internazionali. Elenchi omologazioni UL e VDE disponibile su richiesta.

INAR-LIF LOW INSERTION TERMINALS

In addition to the advantages provided by the consolidated Inarca line of female connectors for lamellar connections, the INAR-LIF line of products also offers its users the added attractions of its low male/female connection forces. Thanks to their special shape, the INAR-LIF products permit a reduction in the connection force required of up to 45%. This makes all connections faster and easier, precludes the risk of dangerous deformations, and improves the overall quality of the assemblies. These products have been designed to divide the connections process into two phases, characterized by the extremely low insertion force required at the outset and the increase to the elevated force required for the subsequent disconnection of the connection made. INAR-LIF products do not require any investments for their introduction in the system because they can be applied with the same equipment used for traditional terminals.

Product characteristics

- Low connection force.
- Available in "straight" and "flag" versions.
- "Flag" versions with reduced size and "F"-shaped crimping of the cable wings.
- High current load capacity.
- Utilizable with standard Inarca insulating caps.

APPROVAL

Inarca products comply with international regulations. UL and VDE approval lists are available on request.

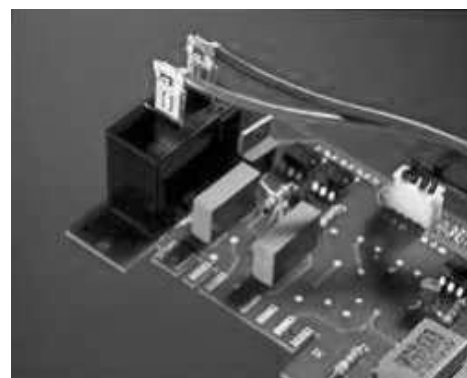
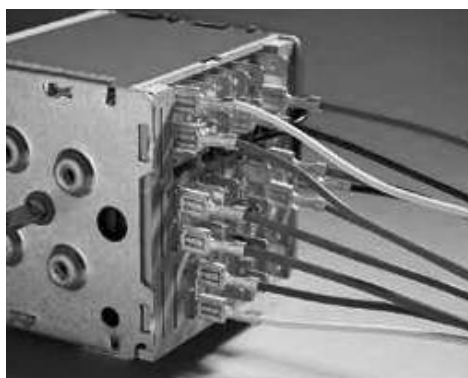

MATERIALI

(vedi pagina 020)

TRATTAMENTI SUPERFICIALI

(vedi pagina 021)

CODICE COLORE

(vedi pagina 026)

MATERIALS

(see page 020)

SURFACE TREATMENTS

(see page 021)

COLOUR CODE

(see page 026)

CONFEZIONI

Le confezioni sono disponibili nel sito www.inarca.it

PACKAGE QUANTITY

Packagings are available at the website www.inarca.it

**INAR-LIF TERMINALI FEMMINA
A BANDIERA INSERIMENTO DOLCE 6,3**
INAR-LIF FLAG TYPE RECEPTACLES 6,3

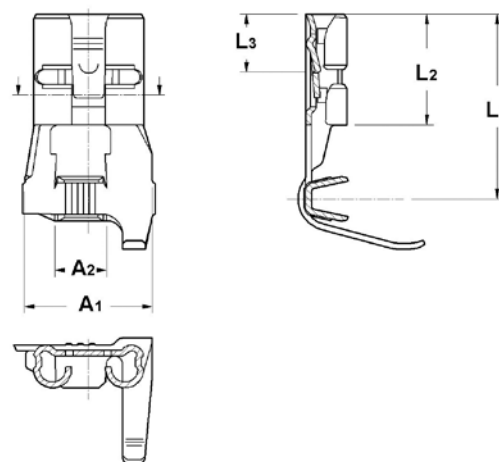

Sez. cavo Wire size (mm ²)	Isolante Insulation (mm)	Dim. maschio Mating tab thk (mm)	Spess. mat. Stock thk (mm)	A1	A2	L1	L2	L3	LI	Materiale Material	Finitura Plating material	Articolo N° P.N.	Note Notes
0,5 ÷ 1,5 (AWG 20 ÷ 15)	1,9 ÷ 3,3	0,8	0,4	8,6	3,5	12,5	7,5	4	×	CuZn		0011351001	[C/Q]
										CuZn	Tin Plated	0011351201	
										CuZn	Silver Plated	0011351301	
										Fe	Ni	0211351127	
										CuNiZn		0911351001	
1,0 ÷ 2,5 (AWG 17 ÷ 13)	2,3 ÷ 4	0,8	0,4	8,6	3,5	12,5	7,5	4	×	CuZn		0011352001	[Q]
										CuZn	Tin Plated	0011352201	
										CuZn	Silver Plated	0011352301	
										Fe	Ni	0211352127	
										CuNiZn		0911352001	

[C/Q] C: Sezione cavo 0,5+0,5 ø Isolante 1,9+1,9

Q: Versione in materiale 'Fe' senza rigature su aletta conduttore

[Q] Versione in materiale 'Fe' senza rigature su aletta conduttore

[C/Q] C: Wire range 0,5+0,5 ø Insulation 1,9+1,9

Q: 'Fe' material version is without serrations on conductor crimping area

[Q] 'Fe' material version is without serrations on conductor crimping area

**INAR-LIF TERMINALI FEMMINA A BANDIERA
INSERIMENTO DOLCE 6,3 SENZA BUGNA**
INAR-LIF FLAG TYPE RECEPTACLES 6,3
WITHOUT INDENTATION

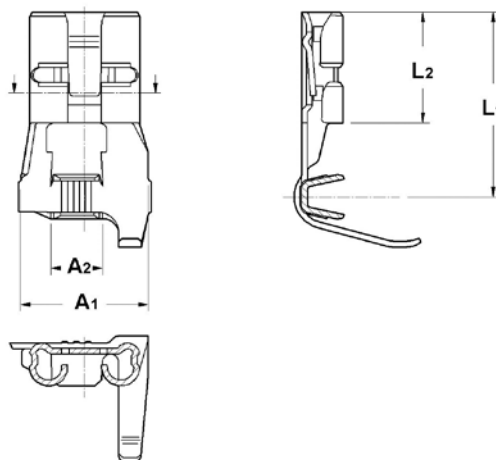

Sez. cavo Wire size (mm ²)	Isolante Insulation (mm)	Dim. maschio Mating tab thk (mm)	Spess. mat. Stock thk (mm)	A1	A2	L1	L2	LI	Materiale Material	Finitura Plating material	Articolo N° P.N.	Note Notes
0,5 ÷ 1,5 (AWG 20 ÷ 15)	1,9 ÷ 3,3	0,8	0,4	8,6	3,5	12,5	7,5	×	CuZn		0011472001	[C]
									CuZn	Tin Plated	0011472201	
									CuZn	Silver Plated	0011472301	
									CuNiZn		0911472001	
1,0 ÷ 2,5 (AWG 17 ÷ 13)	2,3 ÷ 4	0,8	0,4	8,6	3,5	12,5	7,5	×	CuZn		0011473001	
									CuZn	Tin Plated	0011473201	
									CuZn	Silver Plated	0011473301	
									CuNiZn		0911473001	

[C] Sezione cavo 0,5+0,5 ø Isolante 1,9+1,9



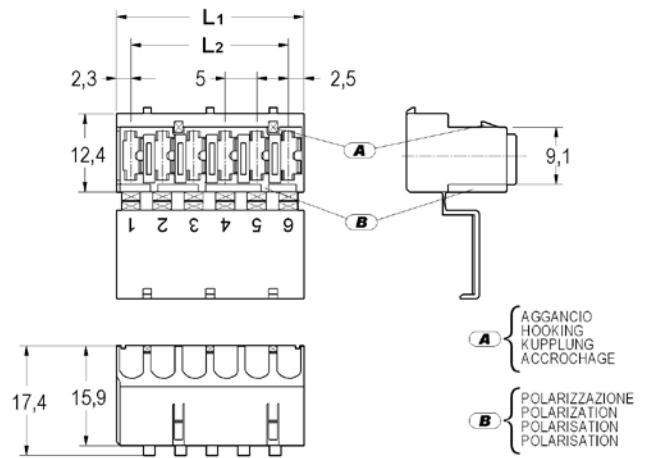

[C] Wire range 0,5+0,5 ø Insulation 1,9+1,9

**INAR-LIF CONNETTORI PER TERMINALI FEMMINA
A BANDIERA INSERIMENTO DOLCE 6,3 RAST 5**
INAR-LIF CONNECTORS FOR FLAG TYPE RECEPTACLES
6,3 RAST 5

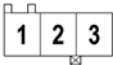
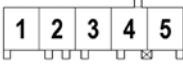

Vie Position	L1	L2	Polarizzazione Polarization	Materiale Material	Articolo N° P.N.	Note Notes
2	9,8	5		PA 66 V-2	0854325700	
				PA 66 V-0	0855325700	
				PA 66 V-0	0863325700	
2	9,8	5		PA 66 V-2	5452009700	
				PA 66 V-0	5552009700	
				PA 66 V-2	6452009700	
2	9,8	5		PA 66 V-2	5452070700	
				PA 66 V-0	6352070700	
3	14,8	10		PA 66 V-2	5450344700	
				PA 66 V-0	5550344700	
				PA 66 V-0	6350344700	
				PA 66 V-2	6450344700	
3	14,8	10		PA 66 V-2	5450345700	
				PA 66 V-0	5550345700	
				PA 66 V-2	6450345700	
3	14,8	10		PA 66 V-2	5452010700	
				PA 66 V-0	5552010700	
				PA 66 V-0	6352010700	
				PA 66 V-2	6452010700	
3	14,8	10		PA 66 V-2	5452016700	
				PA 66 V-0	5552016700	
				PA 66 V-0	6352016700	
				PA 66 V-2	6452016700	
3	14,8	10		PA 66 V-2	5452017700	
				PA 66 V-0	5552017700	
				PA 66 V-0	6352017700	
				PA 66 V-2	6452017700	

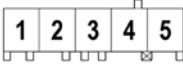
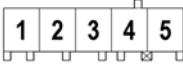
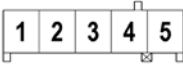
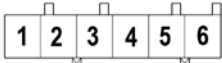
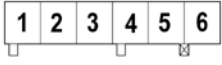
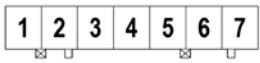
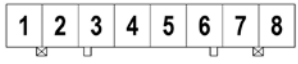
Segue • Follow ➤

Via Position	L1	L2	Polarizzazione Polarization	Materiale Material	Articolo N° P.N.	Note Notes
3	14,8	10		PA 66 V-2	5452018700	
				PA 66 V-0	5552018700	
				PA 66 V-0	6352018700	
				PA 66 V-2	6452018700	
5	24,8	20		PA 66 V-2	5450346700	
				PA 66 V-0	5550346700	
				PA 66 V-0	6350346700	
				PA 66 V-2	6450346700	
5	24,8	20		PA 66 V-2	5450347700	
				PA 66 V-0	5550347700	
				PA 66 V-2	6450347700	
5	24,8	20		PA 66 V-2	5450348700	
				PA 66 V-0	5550348700	
				PA 66 V-2	6450348700	
5	24,8	20		PA 66 V-2	5450349700	
				PA 66 V-0	5550349700	
				PA 66 V-0	6350349700	
				PA 66 V-2	6450349700	
5	24,8	20		PA 66 V-2	5450366700	
				PA 66 V-0	5550366700	
				PA 66 V-2	6450366700	
6	29,8	25		PA 66 V-2	0854327700	
				PA 66 V-0	0855327700	
				PA 66 V-0	0863327700	
6	29,8	25		PA 66 V-2	5452047700	
				PA 66 V-0	5552047700	
				PA 66 V-0	6352047700	
7	34,8	30		PA 66 V-2	5452019700	
				PA 66 V-0	5552019700	
				PA 66 V-2	6452019700	
8	39,8	35		PA 66 V-2	5450357700	
				PA 66 V-0	5550357700	
				PA 66 V-2	6450357700	
8	39,8	35		PA 66 V-2	5450358700	
				PA 66 V-0	5550358700	
				PA 66 V-0	6350358700	

G2

IDC

CONNETTORI INARCA INAR-IDC RAST

In questo capitolo sono presenti i connettori Inarca della serie IDC, suddivisi nelle versioni per connessione diretta su scheda PCB che indiretta, su TAB. Inarca ha esteso a tutta la serie dei connettori IDC alcune caratteristiche peculiari e fondamentali, che in alcuni casi li differenziano da quanto offerto da altre aziende:

- Coperchio unito al corpo connettore da cerniera. Questo permette la terminazione “aperta” e un controllo della stessa prima della chiusura del coperchio.
- Quattro punti di contatto lato IDC.
- Le nuove serie dei connettori RASTS 2,5, 5 TC e 5 PCB sono fornite in catena frontale con un’ottimizzazione dello spazio nelle confezioni, e senza la produzione di sfridi nella separazione.
- Il materiale plastico di base è per tutti: no flame GWT 750°-850°
- La produzione dei terminali e il successivo montaggio è controllato al 100% da sistemi ottici.
- Nelle macchine automatiche di cablaggio, utilizziamo la stessa tecnologia per il controllo della produzione.
- Tutta la gamma delle attrezzature per il cablaggio sono prodotte e fornite da Inarca, vedi capitolo M per le informazioni.

Tipologie di Prodotto.

Sono disponibili 4 serie di prodotti a spostamento d’isolante:

- RAST 2,5
- RAST 2,5 Energy
- RAST 5 TC
- RAST 5 PCB

INARCA INAR-IDC RAST CONNECTORS

In this chapter are present IDC Inarca connectors. They are available for direct mating to the PCB or, for indirect mating to TAB. Inarca has included in all own IDC connectors series some specific and fundamental characteristics. Those in some cases are not the same like offered by other companies on the market:

- The cover is joined to the connector body by hinge. This permit an “open” termination and the possibility to check it before to close the cover.
- Four contact areas to the IDC side
- The new series of RAST 2,5 – RST 5TC and RAST 5 PCB are supplied in frontal chain. This permit to save space in the logistics point of view, and to produce without scraps during the production process.
- Basic the plastic material is no-flame GWT 750°-850°.
- The production of terminals and the assembling to the plastic body, is 100% checked by optical system.
- With the same technology, we check the production of the harness fully automatic machine.
- All the range of IDC tools is produced and supplied by Inarca, for the information see chapter M.

Kind of product.

Now we have available 4 series of products insulation displacement:

- RAST 2,5
- RAST 2,5 Energy
- RAST 5 TC
- RAST 5 PCB

	Passo (mm) Pitch (mm)	Portata di corrente fino a: (A) Rated voltage up to: (A)	Range filo (mm ²) Rated section (mm ²)	Uscita filo Wire direction	Accoppiabile con Connectable with	N° vie Nr. ways
Rast 2,5 - Tutto carico Rast 2,5 - Fully loaded	2,5	2	0,22 ÷ 0,35	90°	Scheda o pin spessore 1,5 mm PCB o pin 1,5 mm thickness	2 ÷ 20
Rast 2,5 - Selettivo Rast 2,5 - Selective loaded	5	4				
Rast 2,5 Energy	5	6	0,35 ÷ 0,75	90° - 180°	Scheda o pin spessore 1,5 mm PCB o pin 1,5 mm thickness	2 ÷ 12
Rast 5 TC	5	10 16	0,35 ÷ 1,0 1,0 ÷ 1,5	90° - 180	Terminale maschio TC 6,3 × 0,8 DIN 46244	2 ÷ 12
Rast 5 PCB	5	6	0,35 ÷ 0,75	90° - 180	Scheda o pin spessore 1,5 mm PCB o pin 1,5 mm thickness	2 ÷ 12

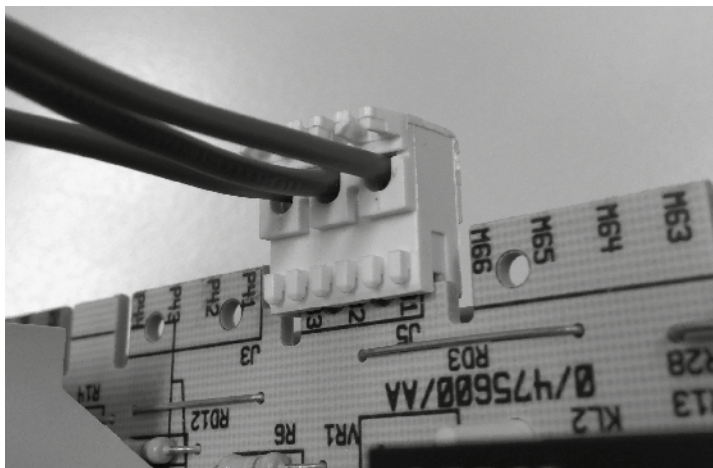

RAST Energy



RAST 5 PCB

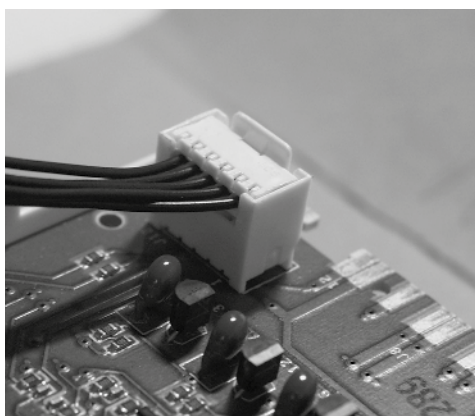

RATS 2,5

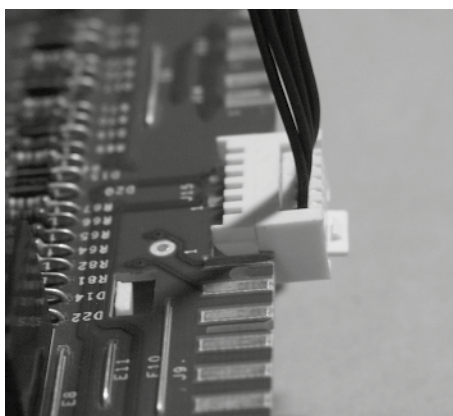

RAST 2,5

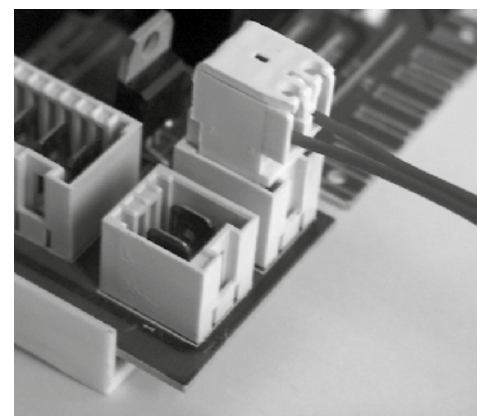

RAST 5 TC

OMOLOGAZIONI

I prodotti Inarca rispondono alle norme internazionali.
Elenchi omologazioni UL e VDE disponibile su richiesta.

CODICE A 10 CIFRE

I codici dei prodotti Inarca sono composti da 10 cifre ed hanno una "struttura parlante":

articolo 8540300701

85 40300701	Tipo di materia prima
8 54 0300701	Serie
854 03 00701	Numero di vie
85403 00 701	Schema
8540300 70 1	Rivestimento superficiale
854030070 1	Stato di fornitura

APPROVAL

Inarca products comply with international regulations.
UL and VDE approval lists are available on request.

10 FIGURES CODE

The Inarca product codes consist of 10 figures and have a "speaking structure":

article 8540300701

85 40300701	Type of raw material
8 54 0300701	Series
854 03 00701	Ways number
85403 00 701	Schema
8540300 70 1	Surface coating
854030070 1	Supply status

INAR-IDC RAST 2,5

Il sistema di connettivazione a spostamento di isolante INAR-RAST 2,5 è stato progettato per essere utilizzato su circuiti stampati. È adatto alla trasmissione di correnti di controllo e di segnali. Sono disponibili connettori da 2 fino a 20 vie polarizzabili dal cablatore, con apposite attrezzature fornite da Inarca.

Il sistema è così composto:

- Housing
- Terminale

SISTEMA DI CONNESSIONE

Il connettore realizzato per collegamenti elettrici da 2 fino a 20 vie alloggia al suo interno i terminali metallici con passo di 2,5 mm. È inoltre possibile realizzare il passo 5 mm caricando selettivamente i terminali. La connessione tra terminali metallici e cavi elettrici avviene applicando la tecnologia a spostamento d'isolante, sfruttando la forma a doppia forcella del terminale. Si ottengono quindi 4 punti di contatto tra terminale e cavo. Successivamente all'operazione di cablaggio, il connettore viene chiuso con il coperchio incernierato, si ottiene così l'isolamento del sistema e la ritenzione meccanica dei fili.

FORNITURA

I connettori INAR-RAST 2,5 vengono forniti con i terminali premontati e con tutte le polarizzazioni presenti. Lo stato di fornitura è in catena frontale (...06). Su richiesta possono essere forniti già polarizzati.

DATI TECNICI**Conduttore**

- Sezione nominale: $0,22 \div 0,35 \text{ mm}^2$ (22 ÷ 24AWG);
- Diametro isolante: 1,20 - 1,70;
- Durezza dell'isolante: Shore A $90^\circ \pm 5^\circ$;
- Il cavo processabile deve essere omologato da Inarca.

Terminale

- Materiale: CuSn;
- Rivestimento superficiale: Sn;
- Portata di corrente: 2÷4 A (vedi derating curve);
- Tensione nomi.: 32 V AC / passo 2,5 mm 250 V AC / passo 5 mm;
- Resistenza di contatto: < 10 mOhm;
- Campo di temperatura: da -40 °C a +110 °C;
- Forza di inserzione su scheda: < 6 N per via;
- Forza di disinserzione da scheda: > 2,5 N per via.

INAR-IDC RAST 2,5

The INAR-RAST 2.5 connector fitting system with shifting of insulation has been designed for use on printed circuits. It is suitable for transmitting control currents and signals. 2-way to 20-way connectors are available which may be polarised by the wiring operator using special equipment supplied by Inarca. The system is composed as follows:

- Housing
- Terminal

CONNECTING SYSTEM

Inside the connector made for 2-way to 20 way electric connection there are metal terminals with pitch 2,5 mm. It is also possible to obtain pitch 5 mm by a selective loading of the terminals. The connection between metal terminals and electric cables is made by applying the technology with shifting of the insulation, making use of the double fork shape of the terminal. Four points of contact between the terminal and the cable are therefore obtained. After the wiring operation, connector is closed by the hinged cover, in this way it obtain the insulation of the system and the mechanical retention of the wires.

SUPPLY

INAR-RAST 2,5 connectors are supplied with all terminals prefitted and with all polarization ribs. The supply status is on tray (...06). They can be supplied polarized on request.

TECHNICAL DATA**Lead**

- Rated section: $0,22 \div 0,35 \text{ mm}^2$ (22 ÷ 24 AWG);
- Insulation diameter: 1,20 - 1,70;
- Insulation hardness: Shore A $90^\circ \pm 5^\circ$;
- The cable to be processed must be approved by Inarca.

Terminal

- Material: CuSn;
- Surface coating: Sn;
- Current capacity: 2÷4 A (see derating curve);
- Rated voltage: 32 V AC / pitch 2,5 mm 250 V AC / pitch 5 mm;
- Contact resistance: < 10 mOhm;
- Temperature range: from -40 °C to +110 °C;
- Connecting force on the PCB: < 6 N each way;
- Disconnecting force from the PCB: > 2,5 N each way.

Corpo in plastica

- Materiale: PA 66 - GWT 750° no flame;
- Classe di autoestinguenza: UL 94 V0;
- Colore: naturale;
- Spessore scheda abbinabile: $1,5 \pm 0,14$ mm;
- Resistenza alle correnti striscianti: CTI = 250 V;
- Distanza in aria: > 1 mm (passo 2,5 mm) > 3 mm (passo 5 mm).

Housing

- Material: PA 66 - GWT 750° no flame;
- Self-extinguishing class: UL 94 V0;
- Color: natural;
- Connectable PCB thickness: $1,5 \pm 0,14$ mm;
- Tracking test: CTI = 250 V;
- Air distance: > 1 mm (pitch 2,5 mm) > 3 mm (pitch 5 mm).

Conduttore
Lead

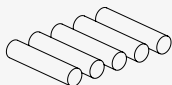

Terminale
Terminal

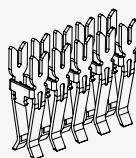

Corpo
in plastica
Housing

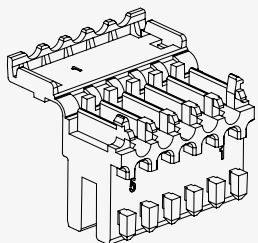

Guscio
Shell

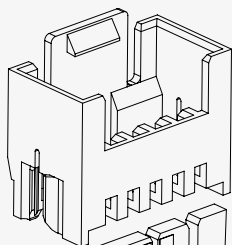

Scheda
PCB

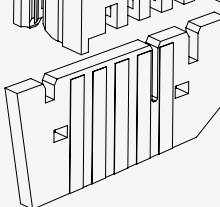

Montaggio
Assembly

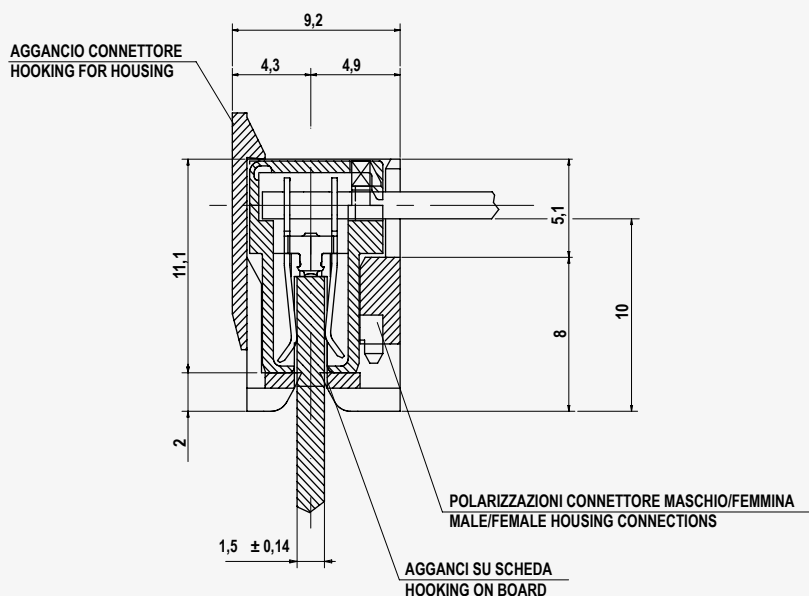
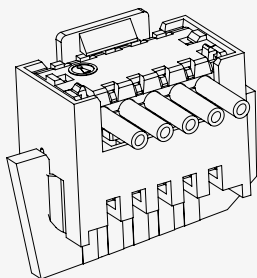

DIMA SCHEDE INAR-IDC RAST 2,5
INAR-IDC RAST 2,5 PCB TEMPLATE

Passo 2,5 mm / Pitch 2,5 mm

N° vie / Nr. ways	A	B
3	5	10,1
4	7,5	12,6
5	10	15,1
6	12,5	17,5
7	15	20,1
8	17,5	22,6
9	20	25,1
10	22,5	27,6
11	25	30,1
12	27,5	32,6
13	30	35,1
14	32,5	37,6
15	35	40,1
16	37,5	42,6
17	40	45,1
18	42,5	47,6
19	45	50,1
20	47,5	52,6

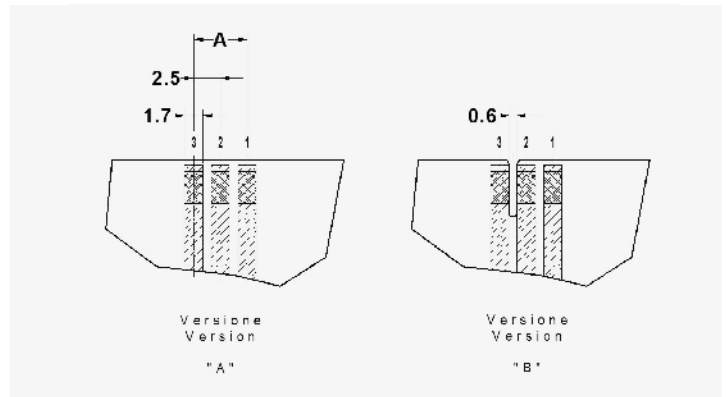

PCB layout – per connettori tipo standard / for standard connectors

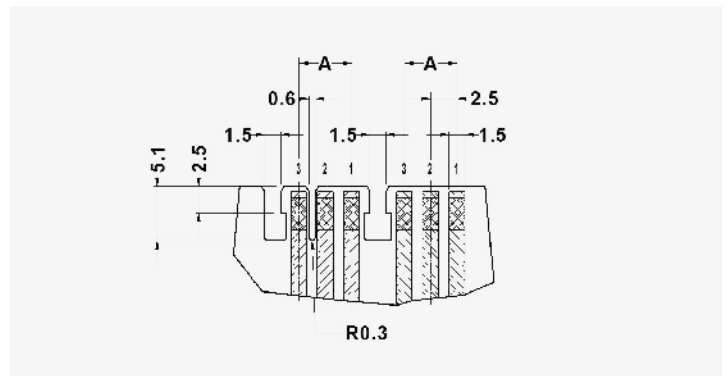

PCB layout – per connettori tipo side-locking / for side-locking connectors

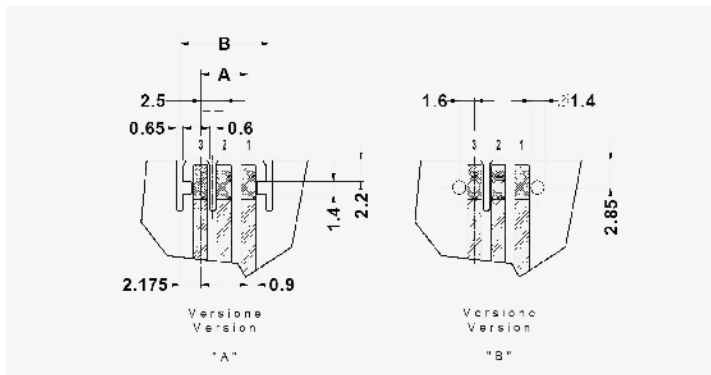

PCB layout – per connettori tipo external-locking / for external-locking connectors

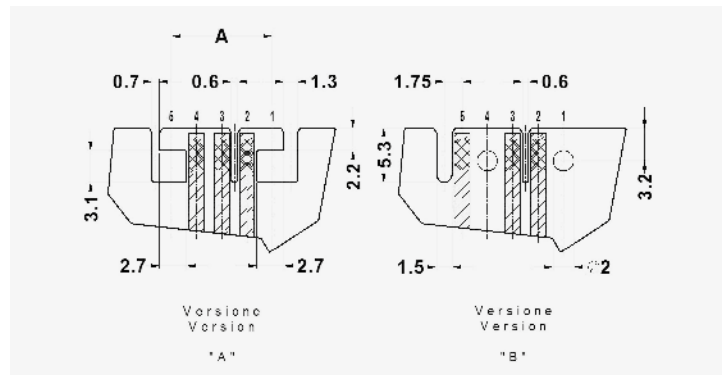

PCB layout – per connettori tipo internal-locking / for internal-locking connectors

Passo 5 mm / Pitch 5 mm

N° vie / Nr. ways	A	B
3	5	10,1
5	10	15,1
7	15	20,1
9	20	25,1
11	25	30,1
13	30	35,1
15	35	40,1
17	40	45,1
19	45	30,5

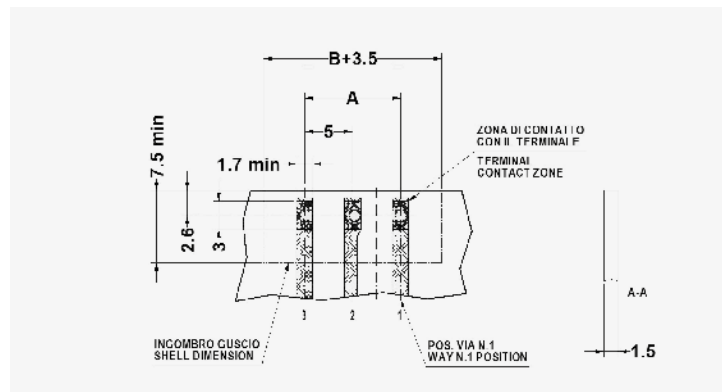

Layout PCB Per Connettori Tipo Standard / PCB Layout For Standard Connectors

INAR-IDC RAST 2,5

N° vie / Nr. ways	L1	L2
3	9,9	5
4	12,4	7,5
5	14,9	10
6	17,4	12,5
7	19,9	15
8	22,4	17,5
9	24,9	20
10	27,4	22,5
11	29,9	25
12	32,4	27,5
13	34,9	30
14	37,4	32,5
15	39,9	35
16	42,4	37,5
17	44,9	40
18	47,4	42,5
19	49,9	45
20	52,4	47,5

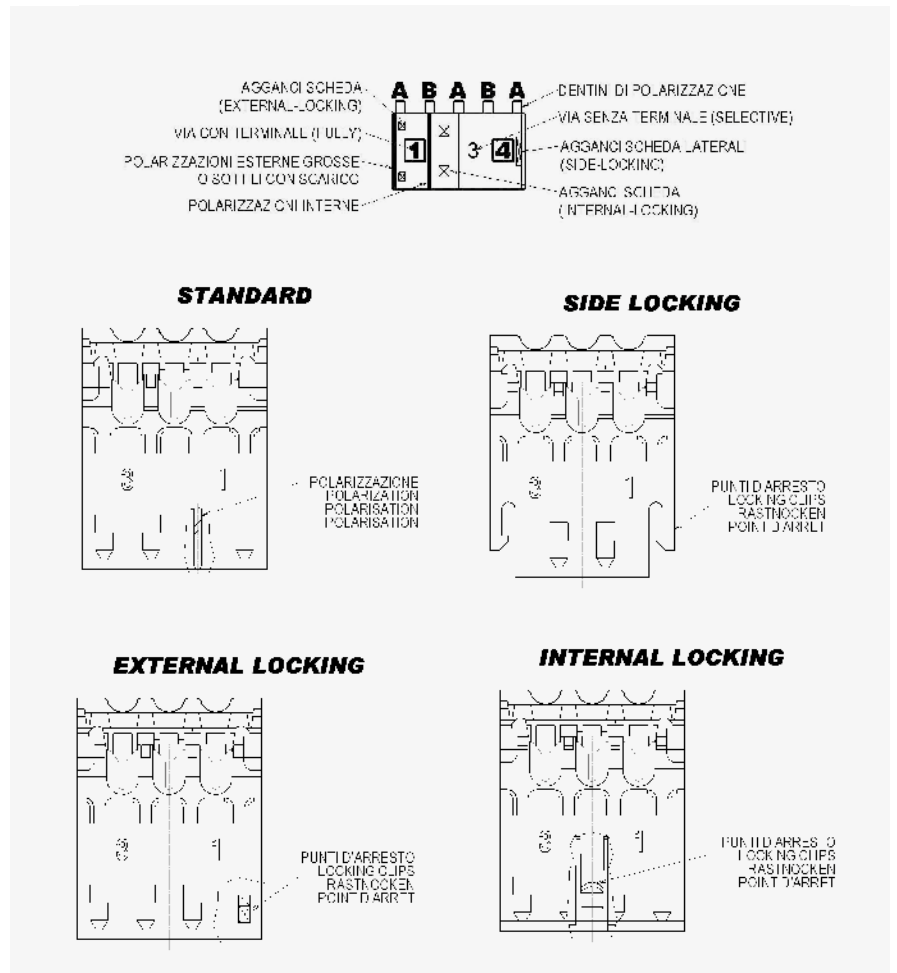
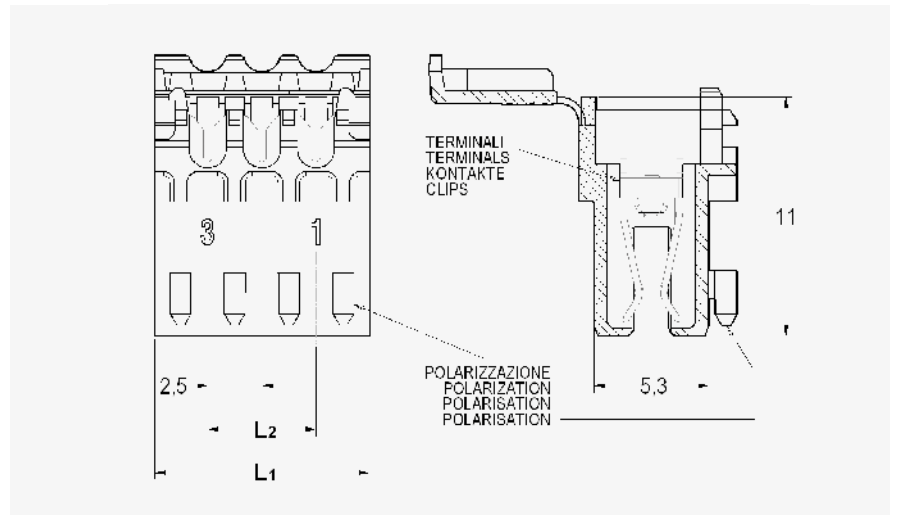

INAR-IDC RAST 2,5 ENERGY

Il sistema di connettorizzazione a spostamento di isolante INAR-RAST 2,5 ENERGY è stato progettato per essere utilizzato su circuiti stampati. È adatto a consentire un passaggio di corrente maggiore rispetto alla tipologia RAST 2,5. I connettori della serie possono avere l'uscita dei cavi anche a 180°, con bloccaggio dei fili sulla portina del connettore.

INAR-IDC RAST 2,5 ENERGY

The system of connection by insulation displacement INAR-RAST 2,5 ENERGY has been designed to be used on printed circuits. It is suited to allow the passage of current higher than the kind RAST 2,5. Connectors of this series can have the exit of cables also at 180°, with locking of wires on the cap of housing.

SCHEDE INAR-IDC RAST 2,5 ENERGY

INAR-DC RAST 2,5 ENERGY PCB

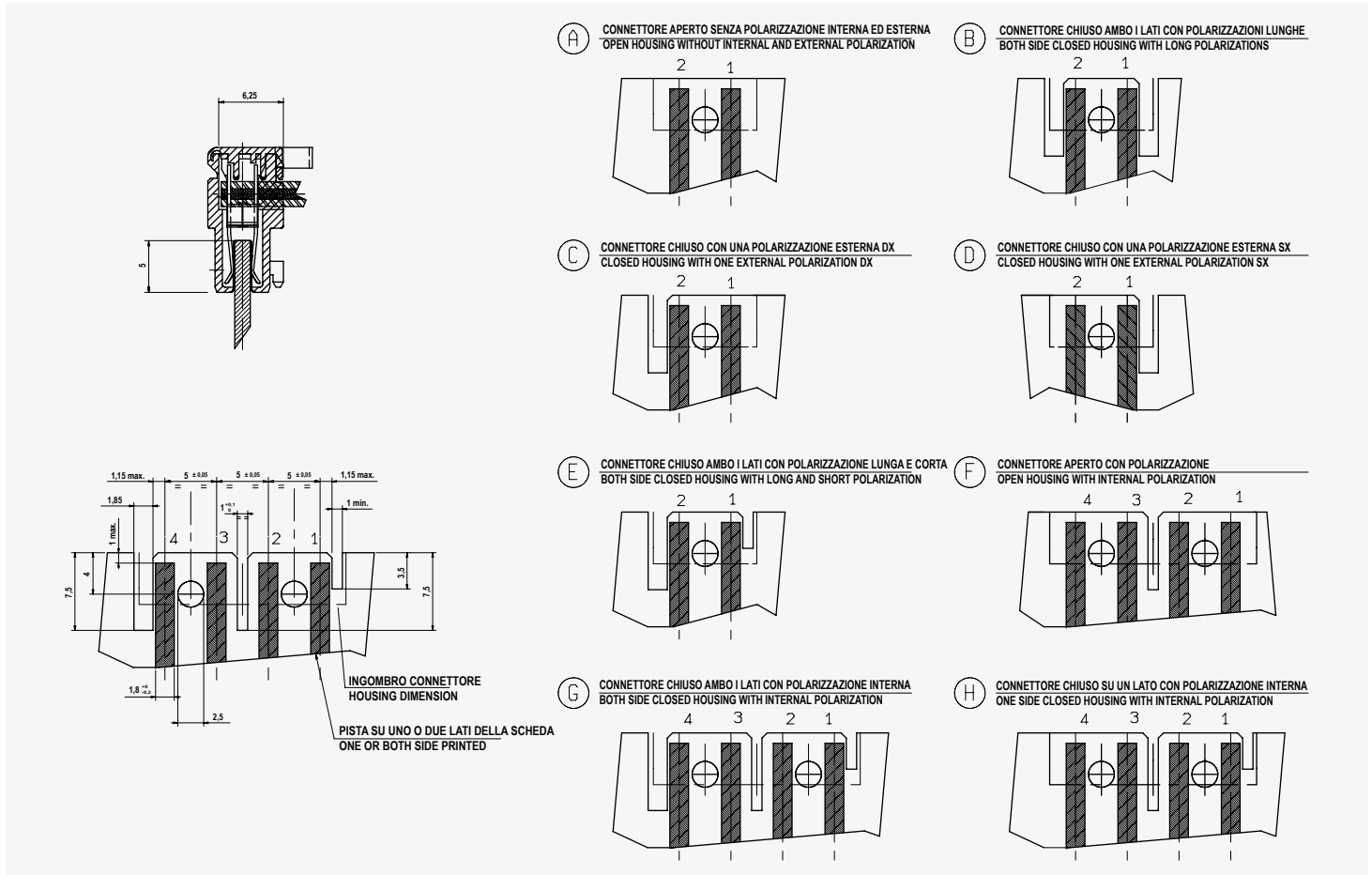

	Rast 2,5	Rast 2,5 Energy
Passo (mm) Pitch (mm)	2,5 mm (terminali su tutte le vie - all the ways) 5,0 mm (se caricato selettivo - if loaded selective)	5,0 mm
Range Filo (mm²) / Rated section (mm²)	0.22 / 0.35 mm ² (24 ÷ 22 AWG)	0.35 / 0.75 mm ²
Portata di corrente (A) / Rated Voltage (A)	Fino a 4 A / Up to 4 A	Fino a 6 A / Up to 6 A
Come riconoscerli How to recognise	RAST 2,5 Energy possiede: dimensioni maggiori, aggancio esterno per il cavo, scarico per l'aggancio sul guscio. RAST 2,5 Energy series have: bigger dimensions, external coupling for cable, slit for the shell coupling.	
Campo di applicazione Application field	Adatto alla trasmissione di segnali e correnti di controllo. / Suitable for transmitting control currents and signal.	Adatto a sopportare applicazioni più gravose. Suitable for heavy applications.
N° fili per ogni terminale/ Nr. of wire for each terminal	1	1
Utilizzabili con gli stessi gusci Usable with the same shell	Si / Yes	Si / Yes

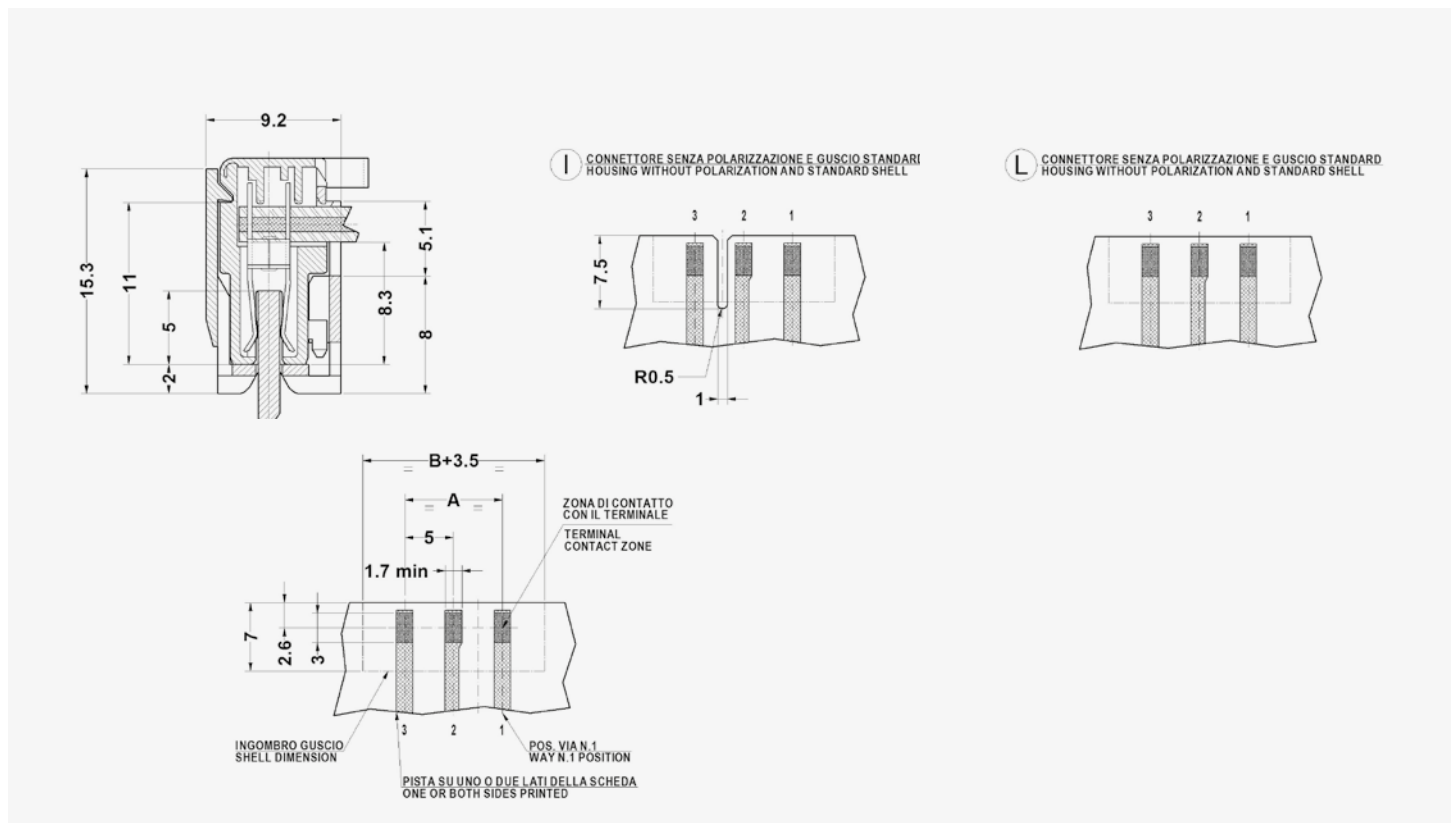

DATI TECNICI

Conduttore

- Sezione nominale: $0,35 \div 0,75 \text{ mm}^2$;
- Diametro isolante: 1,40 - 2,4 mm;
- Durezza dell'isolante: Shore A $90^\circ \pm 5^\circ$;
- Il cavo processabile deve essere omologato da Inarca.

Terminale

- Materiale: CuSn;
- Rivestimento superficiale: Sn;
- Portata di corrente: fino a 6 A (vedi derating curve);
- Tensione nominale: 250 V AC;
- Resistenza di contatto: $< 10 \text{ m}\Omega$;
- Campo di temperatura: da -40°C a $+110^\circ\text{C}$;
- Forza di inserzione su scheda: $< 6 \text{ N}$ per via;
- Forza di disinserzione da scheda: $> 2,5 \text{ N}$ per via.

Corpo in plastica

- Materiale: PA 66 - GWT 750° no flame;
- Classe di autoestinguenza: UL 94 V0;
- Colore: naturale - altri a richiesta;
- Spessore scheda abbinabile: $1,5 \pm 0,14 \text{ mm}$;
- Resistenza alle correnti striscianti: CTI = 250 V;
- Rigidità dielettrica: $> 3000 \text{ V}$;
- Distanza in aria: $> 3 \text{ mm}$.

TECHNICAL DATA

Lead

- Rated section: $0,35 \div 0,75 \text{ mm}^2$;
- Insulation diameter: 1,40 - 2,4 mm;
- Insulation hardness: Shore A $90^\circ \pm 5^\circ$;
- The cable to be processed must be approved by Inarca.

Terminal

- Material: CuSn;
- Surface coating: Sn;
- Current capacity: up to 6 A (see derating curve);
- Rated voltage: 250 V AC;
- Contact resistance: $< 10 \text{ m}\Omega$;
- Temperature range: from -40°C to $+110^\circ\text{C}$;
- Connecting force on the PCB: $< 6 \text{ N}$ each way;
- Disconnecting force from the PCB: $> 2,5 \text{ N}$ each way.

Housing

- Material: PA 66 - GWT 750° no flame;
- Self-extinguishing class: UL 94 V0;
- Color: natural - other colors as requested;
- Connectable PCB thickness: $1,5 \pm 0,14 \text{ mm}$;
- Tracking test: CTI = 250 V;
- Dielectric strength: $> 3000 \text{ V}$;
- Air distance: $> 3 \text{ mm}$.

INAR-IDC RAST 2,5 ENERGY

N° vie / Nr. ways	L1	L2
2	9,9	5
3	14,9	10
4	19,9	15
5	24,9	20
6	29,9	25
7	34,9	30
8	39,9	35
9	44,9	40
10	49,9	45
11	54,9	50
12	59,9	55

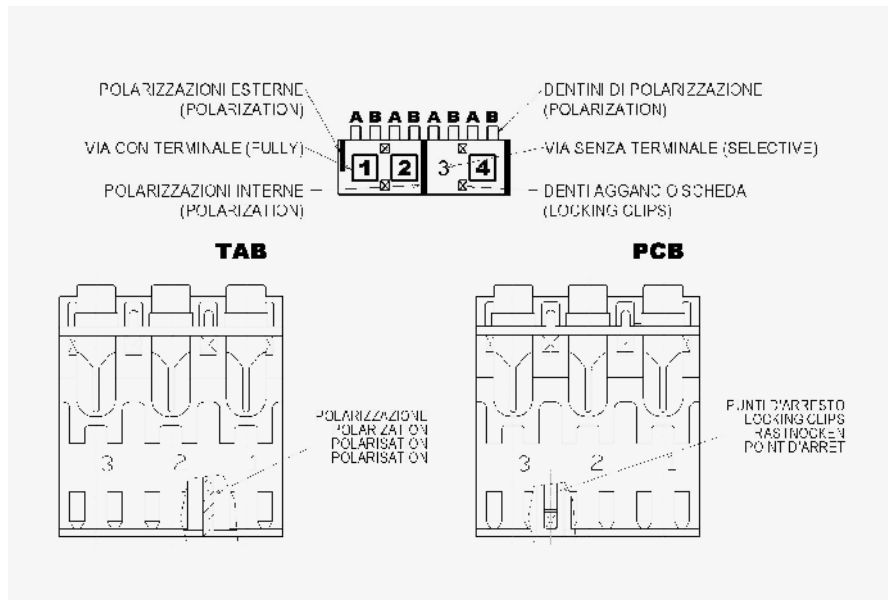
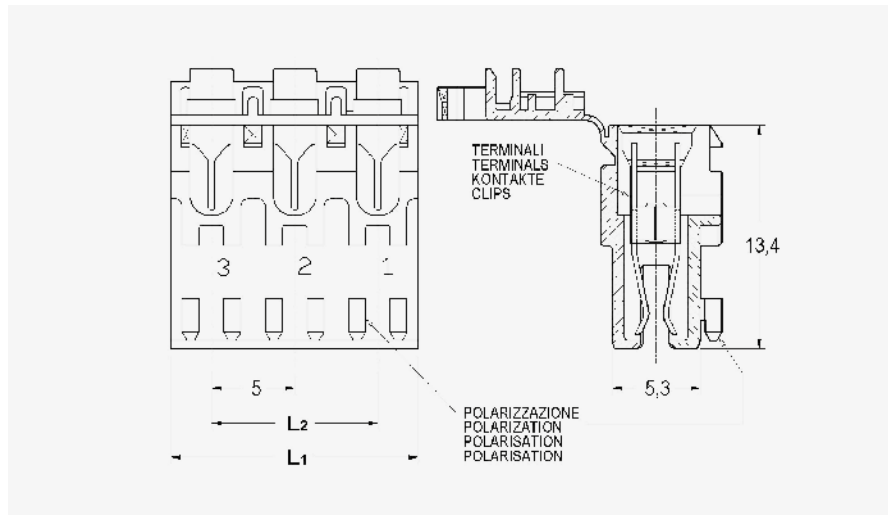

INAR-IDC RAST 5 TC E RAST 5 PCB

La famiglia dei connettori Inarca IDC Rast 5 si compone della versione TC per connessione indiretta su TAB $6,3 \times 0,8$ e della versione PCB per connessione diretta su scheda. Sono connettori che rispettano la norma Rast 5 e quindi il passo è di 5mm. La forma esterna è geometricamente simile, questo permette di utilizzare le stesse attrezzature semiautomatiche e automatiche nella produzione dei cablaggi. Entrambi i connettori sono dotati di apposita sede sul coperchio che consente una uscita cavo a 180° oltre che la standard a 90° . I connettori della famiglia Rast 5 TC e PCB vengono forniti agganciati uno all'altro in catene frontali. Il particolare sistema utilizzato ha il pregio di non generare sfridi in fase di separazione dei connettori. Dal punto di vista della qualità della connessione: sia i connettori Rast 5 TC che Rast 5 PCB utilizzano due punti di contatto sia nell'area IDC sia nell'area contatto su TAB o PCB. Altra caratteristica importante è il tipo range dei fili processabili: Nella versione Rast 5 TC a 10A, da $0,35$ a 1 mm^2 / e a 16A da 1 a $1,5 \text{ mm}^2$ Nella versione RAST 5 PCB da $0,35$ a $0,75$.

INAR-IDC RAST 5 TC E RAST 5 PCB

Inarca IDC RAST 5 series is composed of TC version for indirect connection on TAB $6,3 \times 0,8$ and PCB version for direct connection on board. These connectors normally respect Rast 5 rule and the pitch is 5mm. The outside shape is geometrically similar, this permits to use the same semi-automatic and automatic tools to produce harnesses. Both connectors have a particular seat on the cover allowing a cable exit at 180° , beyond the standard one at 90° . Rast 5 TC and PCB series connectors are supplied hooked one to each other in frontal chains. This particular system avoids to produce swarf when the connectors are being split. About the connection quality, both Rast 5 TC and Rast 5 PCB connectors usually use two contact points: in the IDC area and in the contact area on TAB or PCB. Another important feature is the kind of range of the processable wires: In Rast 5 TC version at 10A, from $0,35$ to 1 mm^2 / and at 16A from $1,0$ to $1,5 \text{ mm}^2$ In Rast 5 PCB version from $0,35$ to $0,75$.

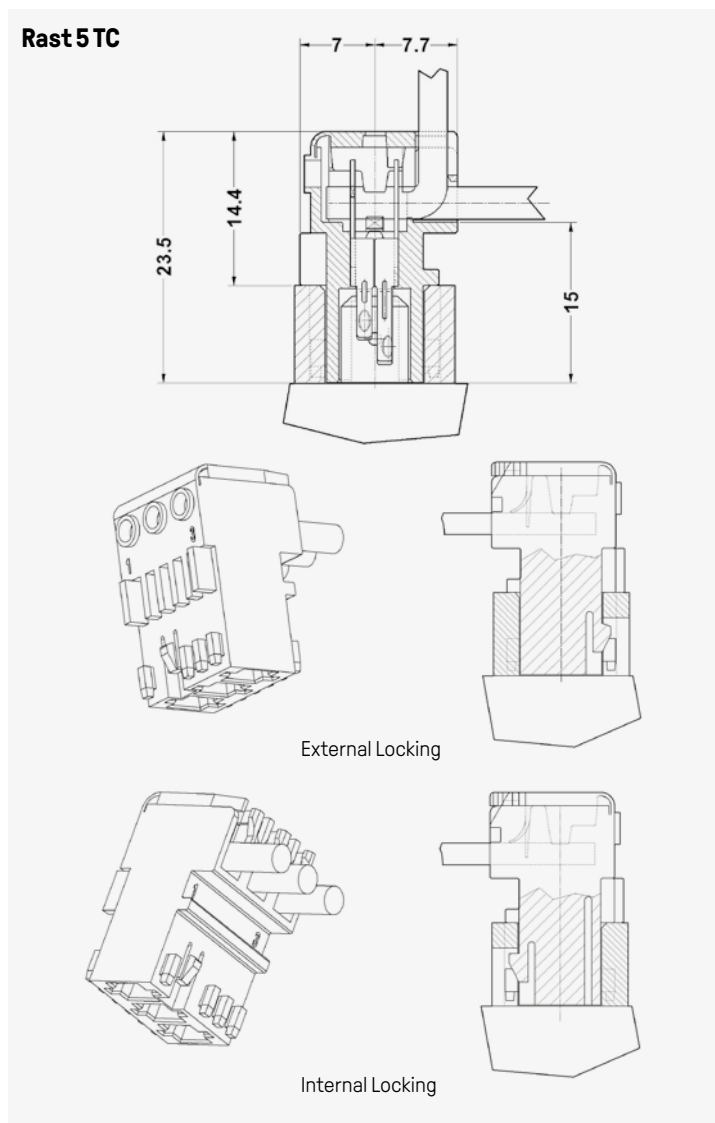
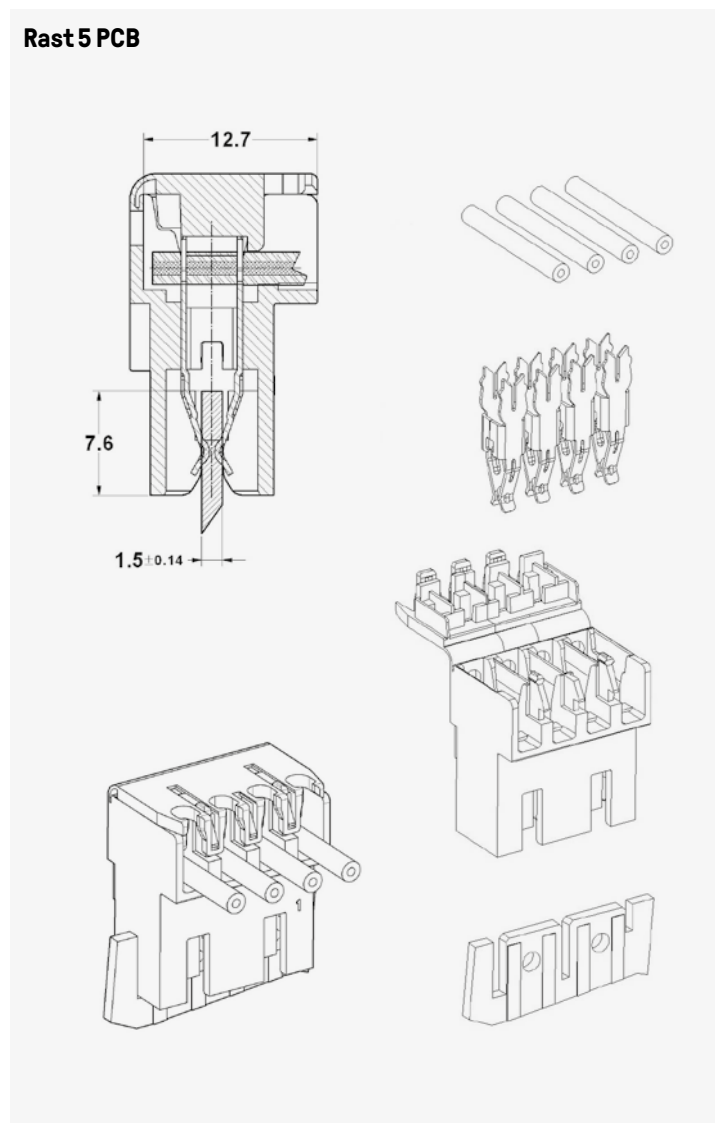
Rast 5 TC**Rast 5 PCB**

DATI TECNICI**Conduttore**

- Sezione nominale: versione fino a 10A 0,35 - 1 mm² / versione fino a 16A 1 - 1,5 mm²;
- Diametro isolante: 1,40 - 3,00 mm;
- Durezza dell'isolante: Shore A 90° ± 5°;
- Il cavo processabile deve essere omologato da Inarca.

Terminale

- Materiale: per 10A CuZn / per 16A CuNiSiMg;
- Rivestimento superficiale: Sn;
- Portata di corrente: fino a 10A e fino a 16A (vedi derating curve);
- Tensione nominale: 250 V AC;
- Resistenza di contatto: < 5 mOhm;
- Campo di temperatura: da -40 °C a +110 °C;
- Forza di inserzione su terminale maschio: < 6 N per via;
- Forza di disinserzione da terminale maschio: > 3 N per via.

Housing

- Materiale: PA 66; - GWT 750° no flame;
- Classe di autoestinguenza: UL 94 V0;
- Colore: naturale per 10A / grigio per 16A;
- Accoppiabile con terminale maschio 6,3 × 0,8 conforme alla norma DIN 46244 e EN 61210;
- Resistenza alle correnti striscianti: CTI = 250 V;
- Rigidità dielettrica: > 3000 V;
- Distanza in aria: > 3 mm.

Per le attrezzature atte a processare questi connettori, vi rimandiamo alla sezione M del catalogo.

MATERIALI

(vedi pagina 020)

TRATTAMENTI SUPERFICIALI

(vedi pagina 021)

CODICE COLORE

(vedi pagina 026)

CONFEZIONI

Le confezioni sono disponibili nel sito www.inarca.it

TECHNICAL DATA**Lead**

- Wire range: version up to 10A 0,35 - 1 mm² / version up to 16A 1 - 1,5mm²
- Insulation diameter: 1,40 - 3,00 mm;
- Insulation hardness: Shore A 90° ± 5°;
- The cable to be processed must be approved by Inarca.

Terminal

- Material: for 10A CuZn / for 16A CuNiSiMg;
- Surface coating: Sn;
- Current Capacity: Up to 10A and up to a 16A (see derating curve);
- Rated voltage: 250 V AC;
- Contact resistance: < 5 mOhm;
- Temperature range: from -40 °C to +110 °C;
- Connecting force on the tab: < 6 N each way;
- Disconnecting force from the tab: > 3 N each way.

Housing

- Material: PA 66; - GWT 750° no flame;
- Self-extinguishing class: UL 94 V0;
- Color: natural for 10A / grey for 16A;
- For use with male tab 6,3 × 0,8 according to DIN 46244 and EN 61210;
- Tracking test: CTI = 250 V;
- Dielectric strength: > 3000 V;
- Air distance: > 3 mm.

Concerning tools used to process these connectors, please see section M of our catalogue.

MATERIALS

(see page 020)

SURFACE TREATMENTS

(see page 021)

COLOUR CODE

(see page 026)

PACKAGE QUANTITY

Packagings are available at the website www.inarca.it

	Dati tecnici Technical data	Rast 2,5	Rast 2,5 Energy	Rast 5 TC	Rast 5 PCB
CONDUTTORE / LEAD	Sezione nominale: Rated section:	0,22 ÷ 0,35 mm ² (22÷24 AWG)	0,35 ÷ 0,75 mm ² (22÷19 AWG)	0,35 ÷ 1,5 mm ² (22÷15 AWG)	0,35 ÷ 0,75 mm ² (22÷19 AWG)
	Diametro isolante: Insulation diameter:	1,2 ÷ 1,7 mm	1,40 ÷ 2,40 mm	1,40 ÷ 3,00 mm	1,40 ÷ 2,40 mm
	Durezza dell'isolante: Insulation hardness:	Shore A 90° ± 5°	Shore A 90° ± 5°	Shore A 90° ± 5°	Shore A 90° ± 5°
		Il cavo processabile deve essere omologato da Inarca The cable to be processed must be approved by Inarca			
TERMINALE / TERMINAL	Materiale: Material:	CuSn	CuSn	CuZn - CuNiSiMg	CuZn
	Rivestimento superficiale: Surface coating:	Pre-TIN	Pre-TIN	Pre-TIN	Pre-TIN
	Portata di corrente: Current capacity:	2÷4 A (v. derating curve) 2÷4 A (see derating curve)	fino a 6 A (v. derating curve) up to 6 A (see derating curve)	fino a 16 A (v. derating curve); up to 16 A (see derating curve)	fino a 6 A (v. derating curve) up to 6 A (see derating curve)
	Tensione nominale: Rated voltage:	32 V AC/Rast 2,5 mm 250 V AC/Rast 5 mm	250 V AC	250 V AC	250 V AC
	Resistenza di contatto: Contact resistance:	< 10 mOhm	< 10 mOhm	< 5 mOhm	< 10 mOhm
	Campo di temperatura: Temperature range:	da/from -40 °C a/to +125 °C	da/from -40 °C a/to +125 °C	da/from -40 °C a/to +110 °C (CuZn) da/from -40 °C a/to +125 °C (CuNiSiMg)	da/from -40 °C a/to +110 °C (CuZn)
	Forza di inserzione su: Connecting force on:	scheda: < 6 N per via PCB: < 6 N each way	scheda: < 9 N per via PCB: < 9 N each way	terminale maschio: < 10 N per via tab: < 10 N each way	
Forza di disinserzione da: Disconnecting force from:	scheda: > 2,5 N per via PCB: > 2,5 N each way	scheda: > 2,5 N per via PCB: > 2,5 N each way	terminale maschio: > 3 N per via tab: > 3 N each way		
HOUSING	Materiale: Material:	PA 66	PA 66	PA 66	PA 66
	Glow wire test	750°C no flame	750°C no flame	750°C no flame	750°C no flame
	Colore: Color:	naturale natural	naturale natural	naturale 10A - grigio 16A natural 10A - grey 16A	naturale natural
	Abbinabile con: Connectable with:	Scheda o pin spessore: PCB or pin thickness 1,5 ± 0,14 mm	Scheda o pin spessore: PCB or pin thickness 1,5 ± 0,14 mm	Terminale maschio Tab 6,3x0,8 - DIN 46244	Scheda o pin spessore: PCB or pin thickness 1,5 ± 0,14 mm
	Resistenza alle correnti striscianti: / Tracking test:	CTI 250 V	CTI 250 V	CTI 250 V	CTI 250 V
	Rigidità Dielettrica: Dielectric strength:	1250 V/Rast 2,5 mm 3000 V/Rast 5 mm	3000 V	3000 V	3000 V
	Distanza in aria: Air distance:	> 1 mm (Rast 2,5 mm) > 3 mm (Rast 5 mm)	> 3 mm	> 3 mm	> 3 mm
Numero di vie: Number of ways:	3 ÷ 20	2 ÷ 12	2 ÷ 10	2 ÷ 12	

INAR-IDC RAST 5 TC

N° vie / Nr. ways	L1	L2
2	10	5
3	15	10
4	20	15
5	25	20
6	30	25
7	35	30
8	40	35
9	45	40
10	50	45

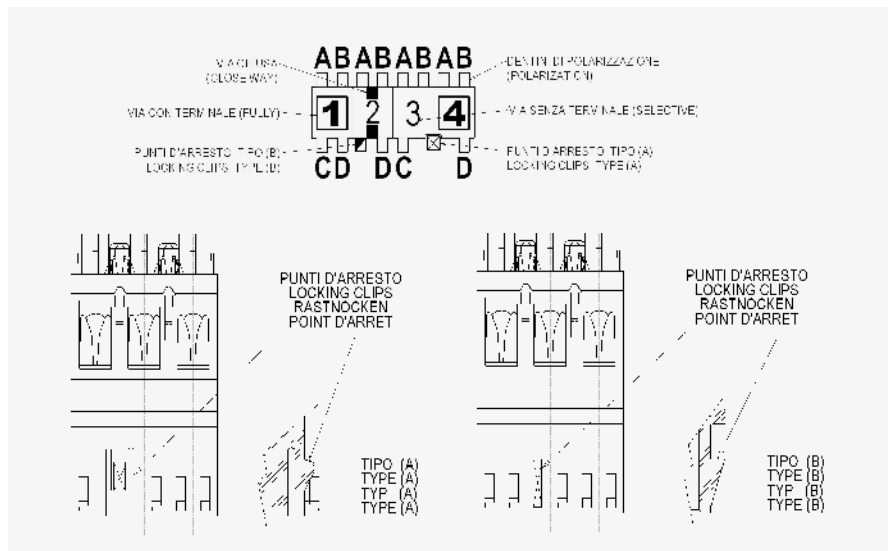
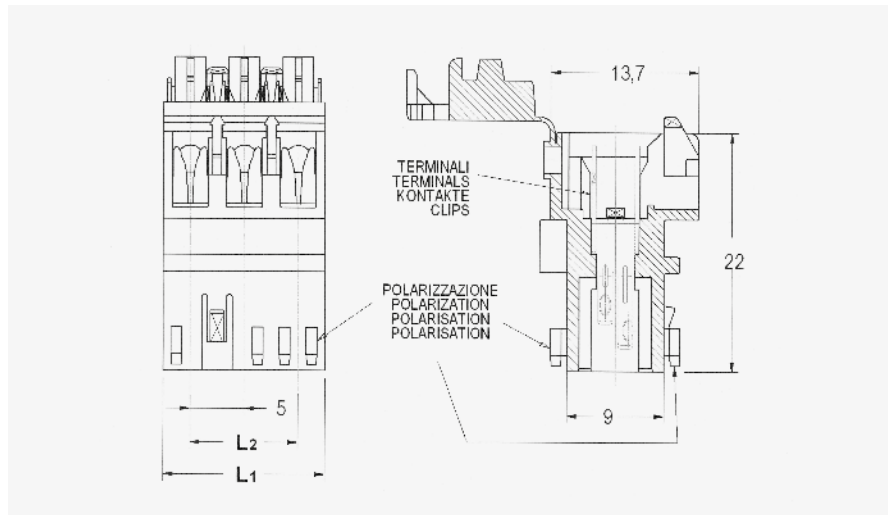

INAR-IDC RAST 5 PCB

N° vie / Nr. ways	L1	L2
2	9,9	5
3	14,9	10
4	19,9	15
5	24,9	20
6	29,9	25
7	34,9	30
8	39,9	35
9	44,9	40
10	49,9	45
11	54,9	50
12	59,9	55

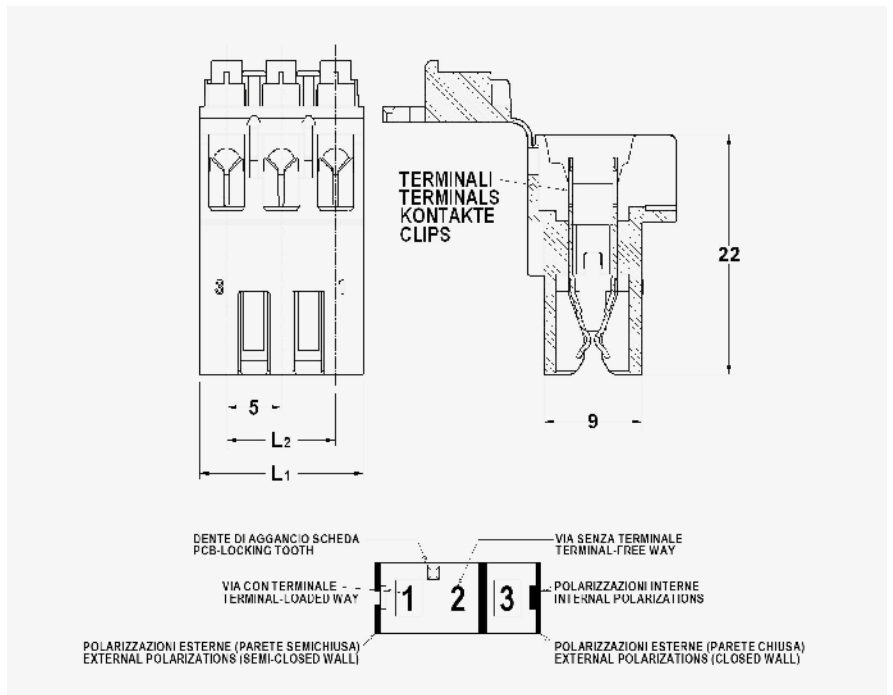

G2

INAR-IDC RAST 2,5 Connector system

INAR-IDC CONNETTORI RAST 2,5 STANDARD
INAR-IDC CONNECTORS RAST 2,5 STANDARD

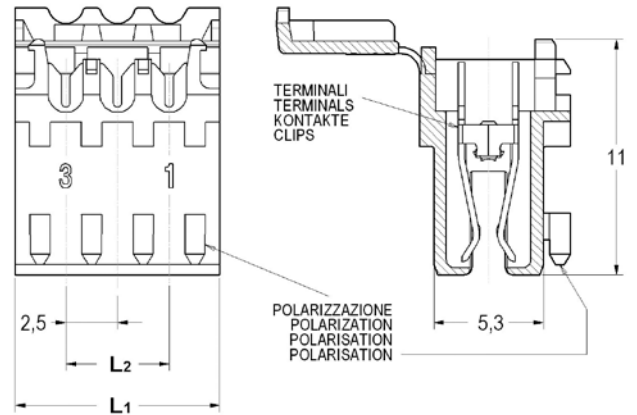

Layout	Schema Pc board layout	Bobina Reel	Catena Chain	Materiale Material	Articolo N° P.N.	Note Notes
		x		PA 66 V-0	8540300701	
			x	PA 66 V-0	8540300706	
		x		PA 66 V-0	8540301701	
			x	PA 66 V-0	8540301706	
		x		PA 66 V-0	8540302701	
			x	PA 66 V-0	8540302706	
		x		PA 66 V-0	8540303701	
			x	PA 66 V-0	8540303706	
		x		PA 66 V-0	8540304701	
			x	PA 66 V-0	8540304706	
		x		PA 66 V-0	8540306701	
			x	PA 66 V-0	8540306706	
		x		PA 66 V-0	8540307701	
			x	PA 66 V-0	8540307706	
		x		PA 66 V-0	8540308701	
			x	PA 66 V-0	8540308706	
		x		PA 66 V-0	8540309701	
			x	PA 66 V-0	8540309706	
		x		PA 66 V-0	8540310701	
			x	PA 66 V-0	8540310706	













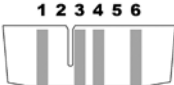

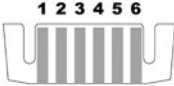

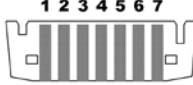
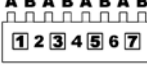

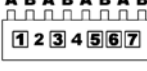





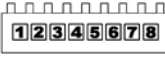

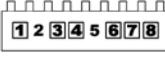
Segue • Follow ➤

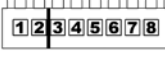
Layout	Schema Pc board layout	Bobina Reel	Catena Chain	Materiale Material	Articolo N° P.N.	Note Notes
		x		PA 66 V-0	8540311701	
			x	PA 66 V-0	8540311706	
		x		PA 66 V-0	8540313701	
			x	PA 66 V-0	8540313706	
		x		PA 66 V-0	8540314701	
			x	PA 66 V-0	8540314706	
		x		PA 66 V-0	8540317701	
			x	PA 66 V-0	8540317706	
		x		PA 66 V-0	8540318701	
			x	PA 66 V-0	8540318706	
		x		PA 66 V-0	8540324701	
			x	PA 66 V-0	8540324706	
		x		PA 66 V-0	8540325701	
			x	PA 66 V-0	8540325706	
		x		PA 66 V-0	8540328701	
			x	PA 66 V-0	8540328706	
			x	PA 66 V-0	8540333706	
		x		PA 66 V-0	8540335701	
			x	PA 66 V-0	8540335706	
		x		PA 66 V-0	8540400701	
			x	PA 66 V-0	8540400706	
		x		PA 66 V-0	8540406701	
			x	PA 66 V-0	8540406706	
		x		PA 66 V-0	8540409701	
			x	PA 66 V-0	8540409706	
		x		PA 66 V-0	8540410701	
			x	PA 66 V-0	8540410706	
		x		PA 66 V-0	8540500701	
			x	PA 66 V-0	8540500706	

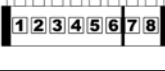
Segue • Follow ➔

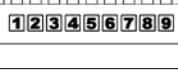
Layout	Schema Pc board layout	Bobina Reel	Catena Chain	Materiale Material	Articolo N° P.N.	Note Notes
		x		PA 66 V-0	8540501701	
			x	PA 66 V-0	8540501706	
		x		PA 66 V-0	8540506701	
			x	PA 66 V-0	8540506706	
		x		PA 66 V-0	8540508701	
			x	PA 66 V-0	8540508706	
		x		PA 66 V-0	8540509701	
			x	PA 66 V-0	8540509706	
		x		PA 66 V-0	8540520701	
			x	PA 66 V-0	8540520706	
		x		PA 66 V-0	8540600701	
			x	PA 66 V-0	8540600706	
		x		PA 66 V-0	8540603701	
			x	PA 66 V-0	8540603706	
		x		PA 66 V-0	8540609701	
			x	PA 66 V-0	8540609706	
		x		PA 66 V-0	8540611701	
			x	PA 66 V-0	8540611706	
		x		PA 66 V-0	8540612701	
			x	PA 66 V-0	8540612706	
		x		PA 66 V-0	8540613701	
			x	PA 66 V-0	8540613706	
		x		PA 66 V-0	8540614701	
			x	PA 66 V-0	8540614706	
		x		PA 66 V-0	8540615701	
			x	PA 66 V-0	8540615706	
		x		PA 66 V-0	8540616701	
			x	PA 66 V-0	8540616706	
		x		PA 66 V-0	8540617701	
			x	PA 66 V-0	8540617706	

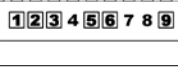
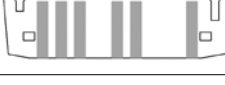
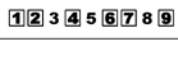
Segue • Follow ➔

Layout	Schema Pc board layout	Bobina Reel	Catena Chain	Materiale Material	Articolo N° P.N.	Note Notes
		x		PA 66 V-0	8540619701	
			x	PA 66 V-0	8540619706	
		x		PA 66 V-0	8540620701	
			x	PA 66 V-0	8540620706	
		x		PA 66 V-0	8540622701	
			x	PA 66 V-0	8540622706	
		x		PA 66 V-0	8540700701	
			x	PA 66 V-0	8540700706	
		x		PA 66 V-0	8540701701	
			x	PA 66 V-0	8540701706	
		x		PA 66 V-0	8540704701	
			x	PA 66 V-0	8540704706	
		x		PA 66 V-0	8540709701	
			x	PA 66 V-0	8540709706	
		x		PA 66 V-0	8540712701	
			x	PA 66 V-0	8540712706	
		x		PA 66 V-0	8540800701	
			x	PA 66 V-0	8540800706	
		x		PA 66 V-0	8540802701	
			x	PA 66 V-0	8540802706	
		x		PA 66 V-0	8540806701	
			x	PA 66 V-0	8540806706	
		x		PA 66 V-0	8540808701	
			x	PA 66 V-0	8540808706	
		x		PA 66 V-0	8540900701	
			x	PA 66 V-0	8540900706	
		x		PA 66 V-0	8540901701	
			x	PA 66 V-0	8540901706	
		x		PA 66 V-0	8540904701	
			x	PA 66 V-0	8540904706	

Segue • Follow ➔

Layout	Schema Pc board layout	Bobina Reel	Catena Chain	Materiale Material	Articolo N° P.N.	Note Notes
		x		PA 66 V-0	8540911701	
		x	x	PA 66 V-0	8541000701	
		x	x	PA 66 V-0	8541003701	
		x	x	PA 66 V-0	8541004701	
		x	x	PA 66 V-0	8541100701	
		x	x	PA 66 V-0	8541101701	
		x	x	PA 66 V-0	8541102701	
		x	x	PA 66 V-0	8541200701	
		x	x	PA 66 V-0	8541205701	
		x	x	PA 66 V-0	8541300701	
		x	x	PA 66 V-0	8541301701	
		x	x	PA 66 V-0	8541302701	
		x	x	PA 66 V-0	8541400701	
		x	x	PA 66 V-0	8541500701	
		x	x	PA 66 V-0	8541501701	

Segue • Follow ➔

Layout	Schema Pc board layout	Bobina Reel	Catena Chain	Materiale Material	Articolo N° P.N.	Note Notes
		x		PA 66 V-0	8541600701	
			x	PA 66 V-0	8541600706	
		x		PA 66 V-0	8541700701	
			x	PA 66 V-0	8541700706	
		x		PA 66 V-0	8541701701	
			x	PA 66 V-0	8541701706	
		x		PA 66 V-0	8541800701	
			x	PA 66 V-0	8541800706	
		x		PA 66 V-0	8541900701	
			x	PA 66 V-0	8541900706	
		x		PA 66 V-0	8541901701	
			x	PA 66 V-0	8541901706	
		x		PA 66 V-0	8542000701	
			x	PA 66 V-0	8542000706	

**INAR-IDC CONNETTORI RAST 2,5
SIDE LOCKING**

INAR-IDC CONNECTORS RAST 2,5
SIDE LOCKING

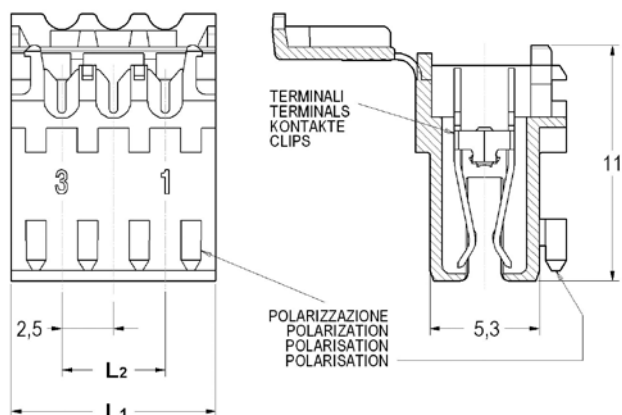

Layout	Schema Pc board layout	Bobina Reel	Catena Chain	Materiale Material	Articolo N° P.N.	Note Notes
		x		PA 66 V-0	8540315701	
			x	PA 66 V-0	8540315706	

Segue • Follow ➔

Layout	Schema Pc board layout	Bobina Reel	Catena Chain	Materiale Material	Articolo N° P.N.	Note Notes
		x		PA 66 V-0	8540316701	
			x	PA 66 V-0	8540316706	
		x		PA 66 V-0	8540320701	
			x	PA 66 V-0	8540320706	
		x		PA 66 V-0	8540322701	
			x	PA 66 V-0	8540322706	
		x		PA 66 V-0	8540323701	
			x	PA 66 V-0	8540323706	
		x		PA 66 V-0	8540333701	
		x		PA 66 V-0	8540334701	
			x	PA 66 V-0	8540334706	
		x		PA 66 V-0	8540402701	
			x	PA 66 V-0	8540402706	
		x		PA 66 V-0	8540404701	
			x	PA 66 V-0	8540404706	
		x		PA 66 V-0	8540415701	
			x	PA 66 V-0	8540415706	
		x		PA 66 V-0	8540502701	
			x	PA 66 V-0	8540502706	
		x		PA 66 V-0	8540504701	
			x	PA 66 V-0	8540504706	
		x		PA 66 V-0	8540505701	
			x	PA 66 V-0	8540505706	
		x		PA 66 V-0	8540507701	
			x	PA 66 V-0	8540507706	
		x		PA 66 V-0	8540514701	
			x	PA 66 V-0	8540514706	
		x		PA 66 V-0	8540604701	
			x	PA 66 V-0	8540604706	

Segue • Follow ➤

Layout	Schema Pc board layout	Bobina Reel	Catena Chain	Materiale Material	Articolo N° P.N.	Note Notes
		x		PA 66 V-0	8540606701	
			x	PA 66 V-0	8540606706	
		x		PA 66 V-0	8540608701	
			x	PA 66 V-0	8540608706	
		x		PA 66 V-0	8540618701	
			x	PA 66 V-0	8540618706	
			x	PA 66 V-0	8540621706	
		x		PA 66 V-0	8540703701	
			x	PA 66 V-0	8540703706	
		x		PA 66 V-0	8540708701	
			x	PA 66 V-0	8540708706	
		x		PA 66 V-0	8540711701	
			x	PA 66 V-0	8540711706	
		x		PA 66 V-0	8540714701	
			x	PA 66 V-0	8540714706	
		x		PA 66 V-0	8540803701	
			x	PA 66 V-0	8540803706	
		x		PA 66 V-0	8540804701	
			x	PA 66 V-0	8540804706	
		x		PA 66 V-0	8540805701	
			x	PA 66 V-0	8540805706	
		x		PA 66 V-0	8540807701	
			x	PA 66 V-0	8540807706	
		x		PA 66 V-0	8540902701	
			x	PA 66 V-0	8540902706	
		x		PA 66 V-0	8540903701	
			x	PA 66 V-0	8540903706	
		x		PA 66 V-0	8540906701	
			x	PA 66 V-0	8540906706	

Segue • Follow ➔





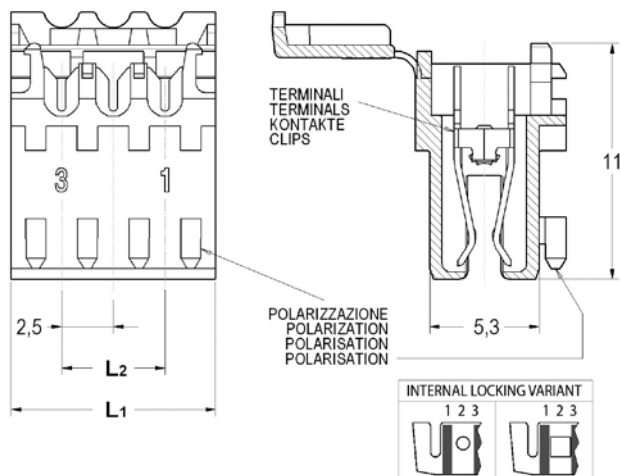





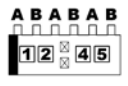
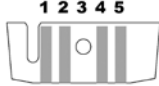

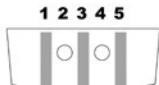
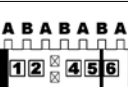

Layout	Schema Pc board layout	Bobina Reel	Catena Chain	Materiale Material	Articolo N° P.N.	Note Notes
		x	x	PA 66 V-0	8540907701	
				PA 66 V-0	8540907706	
		x	x	PA 66 V-0	8540908701	
				PA 66 V-0	8540908706	
		x	x	PA 66 V-0	8540909701	
				PA 66 V-0	8540909706	
		x	x	PA 66 V-0	8540910701	
				PA 66 V-0	8540910706	
		x	x	PA 66 V-0	8541007701	
				PA 66 V-0	8541007706	
		x	x	PA 66 V-0	8541103701	
				PA 66 V-0	8541103706	
		x	x	PA 66 V-0	8541104701	
				PA 66 V-0	8541104706	
		x	x	PA 66 V-0	8541201701	
				PA 66 V-0	8541201706	
		x	x	PA 66 V-0	8541203701	
				PA 66 V-0	8541203706	
		x	x	PA 66 V-0	8541204701	
				PA 66 V-0	8541204706	
		x	x	PA 66 V-0	8541206701	
				PA 66 V-0	8541206706	
		x	x	PA 66 V-0	8541303701	
				PA 66 V-0	8541303706	

**INAR-IDC CONNETTORI RAST 2,5
INTERNAL LOCKING**
INAR-IDC CONNECTORS RAST 2,5
INTERNAL LOCKING

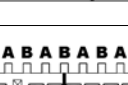
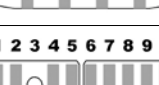
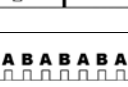

Layout	Schema Pc board layout	Bobina Reel	Catena Chain	Materiale Material	Articolo N° P.N.	Note Notes
		x		PA 66 V-0	8540319701	
			x	PA 66 V-0	8540319706	
		x		PA 66 V-0	8540321701	
			x	PA 66 V-0	8540321706	
		x		PA 66 V-0	8540327701	
			x	PA 66 V-0	8540327706	
		x		PA 66 V-0	8540329701	
			x	PA 66 V-0	8540329706	
		x		PA 66 V-0	8540332701	
			x	PA 66 V-0	8540332706	
		x		PA 66 V-0	8540405701	
			x	PA 66 V-0	8540405706	
		x		PA 66 V-0	8540510701	
			x	PA 66 V-0	8540510706	
		x		PA 66 V-0	8540511701	
			x	PA 66 V-0	8540511706	
		x		PA 66 V-0	8540512701	
			x	PA 66 V-0	8540512706	
		x		PA 66 V-0	8540513701	
			x	PA 66 V-0	8540513706	

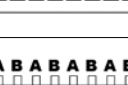
Segue • Follow ➤

Layout	Schema Pc board layout	Bobina Reel	Catena Chain	Materiale Material	Articolo N° P.N.	Note Notes
		x		PA 66 V-0	8540519701	
		x	x	PA 66 V-0	8540521701	
		x	x	PA 66 V-0	8540607701	
		x	x	PA 66 V-0	8540705701	
		x	x	PA 66 V-0	8540706701	
		x	x	PA 66 V-0	8540707701	
		x	x	PA 66 V-0	8541005701	
		x	x	PA 66 V-0	8541401701	
		x	x	PA 66 V-0	8541502701	

**INAR-IDC CONNETTORI RAST 2,5
EXTERNAL LOCKING**
INAR-IDC CONNECTORS RAST 2,5
EXTERNAL LOCKING

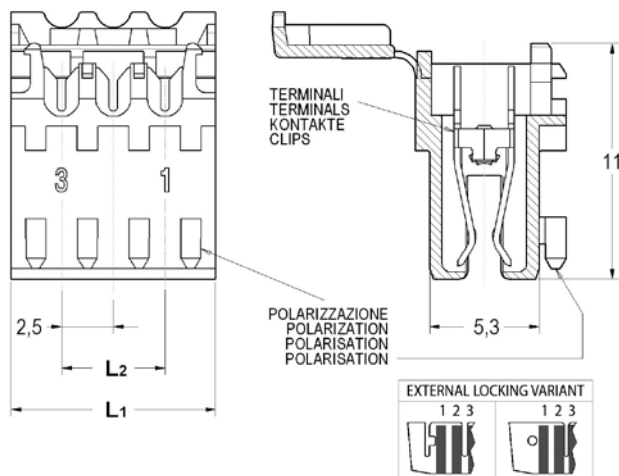

Layout	Schema Pc board layout	Bobina Reel	Catena Chain	Materiale Material	Articolo N° P.N.	Note Notes
		x		PA 66 V-0	8540305701	
			x	PA 66 V-0	8540305706	
		x		PA 66 V-0	8540312701	
			x	PA 66 V-0	8540312706	
		x		PA 66 V-0	8540326701	
			x	PA 66 V-0	8540326706	
		x		PA 66 V-0	8540330701	
			x	PA 66 V-0	8540330706	
		x		PA 66 V-0	8540331701	
			x	PA 66 V-0	8540331706	
		x		PA 66 V-0	8540336701	
			x	PA 66 V-0	8540336706	
		x		PA 66 V-0	8540401701	
			x	PA 66 V-0	8540401706	
		x		PA 66 V-0	8540403701	
			x	PA 66 V-0	8540403706	
		x		PA 66 V-0	8540407701	
			x	PA 66 V-0	8540407706	
		x		PA 66 V-0	8540408701	
			x	PA 66 V-0	8540408706	

Segue • Follow ➤

Layout	Schema Pc board layout	Bobina Reel	Catena Chain	Materiale Material	Articolo N° P.N.	Note Notes
		x		PA 66 V-0	8540411701	
			x	PA 66 V-0	8540411706	
		x		PA 66 V-0	8540412701	
			x	PA 66 V-0	8540412706	
		x		PA 66 V-0	8540413701	
			x	PA 66 V-0	8540413706	
		x		PA 66 V-0	8540414701	
			x	PA 66 V-0	8540414706	
		x		PA 66 V-0	8540503701	
			x	PA 66 V-0	8540503706	
		x		PA 66 V-0	8540515701	
			x	PA 66 V-0	8540515706	
		x		PA 66 V-0	8540516701	
			x	PA 66 V-0	8540516706	
		x		PA 66 V-0	8540517701	
			x	PA 66 V-0	8540517706	
		x		PA 66 V-0	8540518701	
			x	PA 66 V-0	8540518706	
		x		PA 66 V-0	8540522701	
			x	PA 66 V-0	8540522706	
		x		PA 66 V-0	8540601701	
			x	PA 66 V-0	8540601706	
		x		PA 66 V-0	8540602701	
			x	PA 66 V-0	8540602706	
		x		PA 66 V-0	8540605701	
			x	PA 66 V-0	8540605706	
		x		PA 66 V-0	8540610701	
			x	PA 66 V-0	8540610706	
		x		PA 66 V-0	8540623701	
			x	PA 66 V-0	8540623706	

Segue • Follow ➔

Layout	Schema Pc board layout	Bobina Reel	Catena Chain	Materiale Material	Articolo N° P.N.	Note Notes
		x		PA 66 V-0	8540702701	
			x	PA 66 V-0	8540702706	
		x		PA 66 V-0	8540710701	
			x	PA 66 V-0	8540710706	
		x		PA 66 V-0	8540713701	
			x	PA 66 V-0	8540713706	
		x		PA 66 V-0	8540715701	
			x	PA 66 V-0	8540715706	
		x		PA 66 V-0	8540801701	
			x	PA 66 V-0	8540801706	
		x		PA 66 V-0	8540905701	
			x	PA 66 V-0	8540905706	
		x		PA 66 V-0	8540912701	
			x	PA 66 V-0	8540912706	
		x		PA 66 V-0	8540913701	
			x	PA 66 V-0	8540913706	
		x		PA 66 V-0	8541001701	
			x	PA 66 V-0	8541001706	
		x		PA 66 V-0	8541002701	
			x	PA 66 V-0	8541002706	
		x		PA 66 V-0	8541006701	
			x	PA 66 V-0	8541006706	
		x		PA 66 V-0	8541202701	
			x	PA 66 V-0	8541202706	
		x		PA 66 V-0	8541402701	
			x	PA 66 V-0	8541402706	
		x		PA 66 V-0	8541403701	
			x	PA 66 V-0	8541403706	
		x		PA 66 V-0	8541601701	
			x	PA 66 V-0	8541601706	

G2





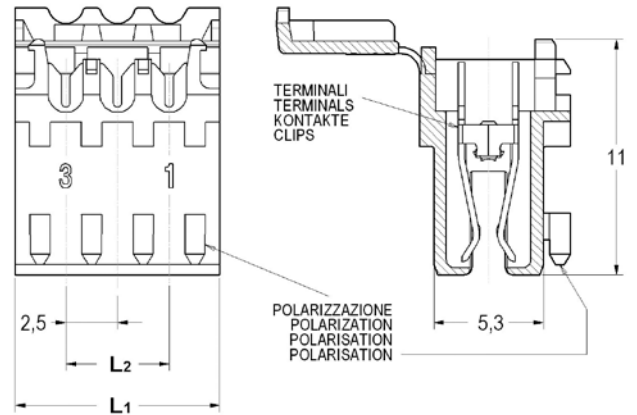





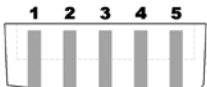

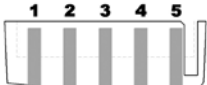

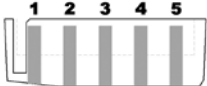



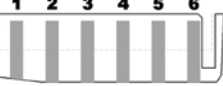

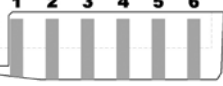



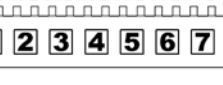

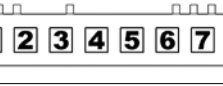

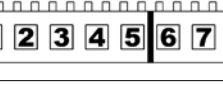
INAR-IDC RAST 2,5 energy Connector system

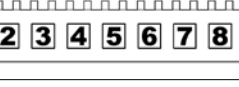
INAR-IDC CONNETTORI RAST 2,5 ENERGY TAB
INAR-IDC CONNECTORS RAST 2,5 ENERGY TAB

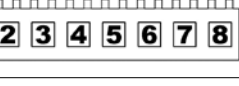

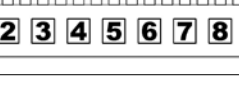







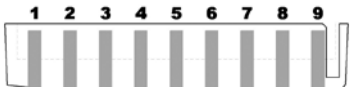

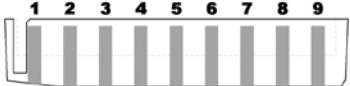

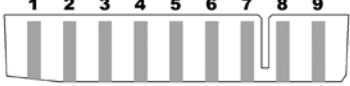







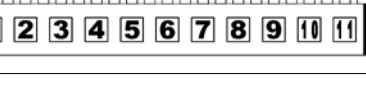

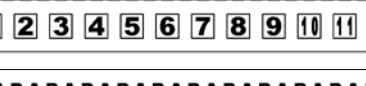
Layout	Schema Pc board layout	Bobina Reel	Catena Chain	Materiale Material	Articolo N° P.N.	Note Notes
		x		PA 66 V-0	8560200701	
		x		PA 66 V-0	8560201701	
		x		PA 66 V-0	8560202701	
		x		PA 66 V-0	8560210701	
		x		PA 66 V-0	8560300701	
		x		PA 66 V-0	8560301701	
		x		PA 66 V-0	8560302701	
		x		PA 66 V-0	8560400701	
		x		PA 66 V-0	8560401701	
		x		PA 66 V-0	8560402701	

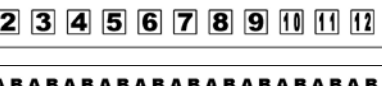
Segue • Follow ➤

Layout	Schema Pc board layout	Bobina Reel	Catena Chain	Materiale Material	Articolo N° P.N.	Note Notes
		x		PA 66 V-0	8560500701	
		x		PA 66 V-0	8560501701	
		x		PA 66 V-0	8560502701	
		x		PA 66 V-0	8560600701	
		x		PA 66 V-0	8560601701	
		x		PA 66 V-0	8560602701	
		x		PA 66 V-0	8560700701	
		x		PA 66 V-0	8560701701	
		x		PA 66 V-0	8560702701	
		x		PA 66 V-0	8560711701	
		x		PA 66 V-0	8560715701	
		x		PA 66 V-0	8560800701	
		x		PA 66 V-0	8560801701	
		x		PA 66 V-0	8560802701	
		x		PA 66 V-0	8560900701	

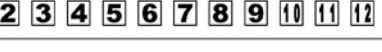
Segue • Follow ➔

Layout	Schema Pc board layout	Bobina Reel	Catena Chain	Materiale Material	Articolo N° P.N.	Note Notes
		x		PA 66 V-0	8560901701	
		x		PA 66 V-0	8560902701	
		x		PA 66 V-0	8560916701	
		x		PA 66 V-0	8561000701	
		x		PA 66 V-0	8561001701	
		x		PA 66 V-0	8561002701	
		x		PA 66 V-0	8561100701	
		x		PA 66 V-0	8561101701	
		x		PA 66 V-0	8561102701	
		x		PA 66 V-0	8561200701	
		x		PA 66 V-0	8561201701	
		x		PA 66 V-0	8561202701	

INAR-IDC CONNETTORI RAST 2,5 ENERGY PCB
INAR-IDC CONNECTORS RAST 2,5 ENERGY EDGE

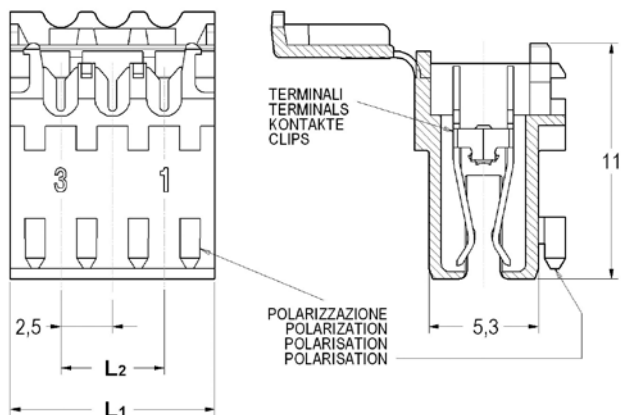









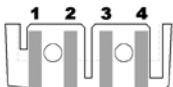

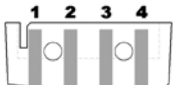

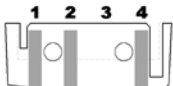

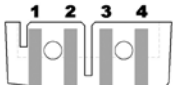

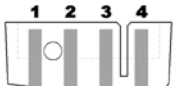

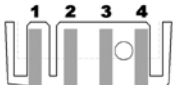

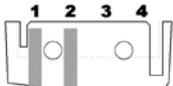

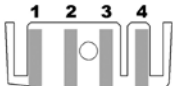

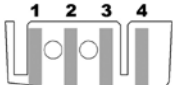

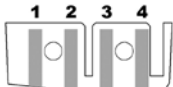

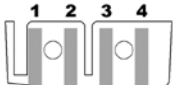

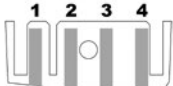
Layout	Schema Pc board layout	Bobina Reel	Catena Chain	Materiale Material	Articolo N° P.N.	Note Notes
		x		PA 66 V-0	8560203701	
		x		PA 66 V-0	8560204701	
		x		PA 66 V-0	8560205701	
		x		PA 66 V-0	8560206701	
		x		PA 66 V-0	8560207701	
		x		PA 66 V-0	8560208701	
		x		PA 66 V-0	8560209701	
		x		PA 66 V-0	8560303701	
		x		PA 66 V-0	8560304701	
		x		PA 66 V-0	8560305701	

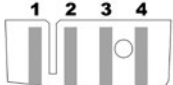
Segue • Follow ➤

Layout	Schema Pc board layout	Bobina Reel	Catena Chain	Materiale Material	Articolo N° P.N.	Note Notes
		x		PA 66 V-0	8560306701	
		x		PA 66 V-0	8560307701	
		x		PA 66 V-0	8560308701	
		x		PA 66 V-0	8560309701	
		x		PA 66 V-0	8560310701	
		x		PA 66 V-0	8560311701	
		x		PA 66 V-0	8560312701	
		x		PA 66 V-0	8560313701	
		x		PA 66 V-0	8560314701	
		x		PA 66 V-0	8560403701	
		x		PA 66 V-0	8560404701	
		x		PA 66 V-0	8560405701	
		x		PA 66 V-0	8560406701	
		x		PA 66 V-0	8560407701	
		x		PA 66 V-0	8560408701	

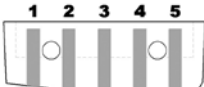









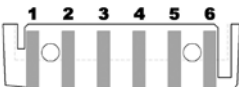

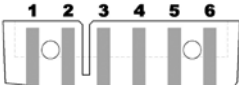

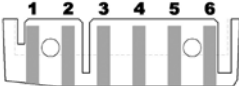

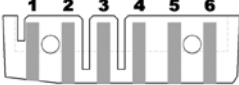

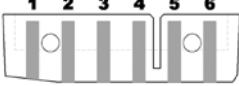

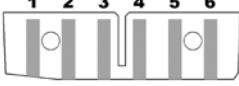

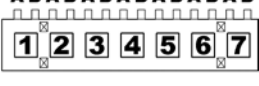
Segue • Follow ➤

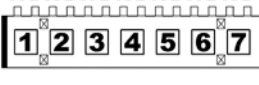
Layout	Schema Pc board layout	Bobina Reel	Catena Chain	Materiale Material	Articolo N° P.N.	Note Notes
		x		PA 66 V-0	8560409701	
		x		PA 66 V-0	8560410701	
		x		PA 66 V-0	8560411701	
		x		PA 66 V-0	8560412701	
		x		PA 66 V-0	8560413701	
		x		PA 66 V-0	8560414701	
		x		PA 66 V-0	8560415701	
		x		PA 66 V-0	8560416701	
		x		PA 66 V-0	8560417701	
		x		PA 66 V-0	8560418701	
		x		PA 66 V-0	8560419701	
		x		PA 66 V-0	8560420701	
		x		PA 66 V-0	8560421701	
		x		PA 66 V-0	8560422701	
		x		PA 66 V-0	8560503701	

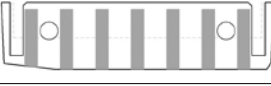

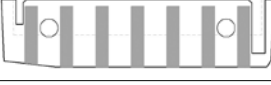

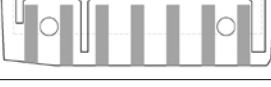
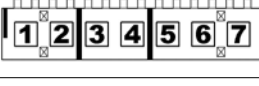
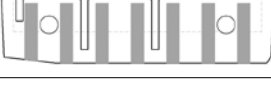
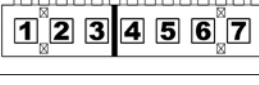
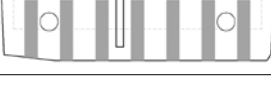





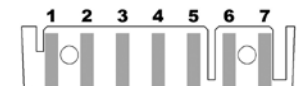

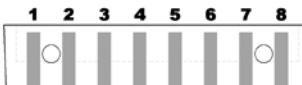

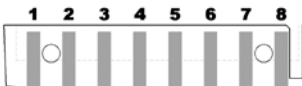

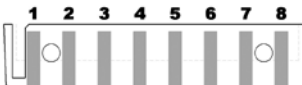

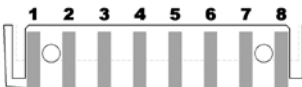

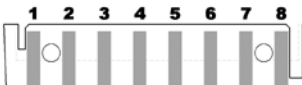

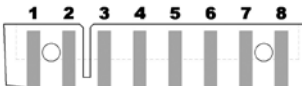

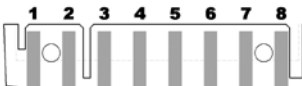

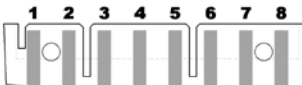

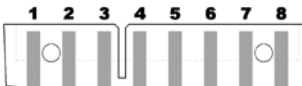
Segue • Follow 

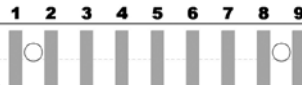
Layout	Schema Pc board layout	Bobina Reel	Catena Chain	Materiale Material	Articolo N° P.N.	Note Notes
		x		PA 66 V-0	8560504701	
		x		PA 66 V-0	8560505701	
		x		PA 66 V-0	8560506701	
		x		PA 66 V-0	8560507701	
		x		PA 66 V-0	8560508701	
		x		PA 66 V-0	8560509701	
		x		PA 66 V-0	8560510701	
		x		PA 66 V-0	8560511701	
		x		PA 66 V-0	8560512701	
		x		PA 66 V-0	8560513701	
		x		PA 66 V-0	8560514701	
		x		PA 66 V-0	8560603701	
		x		PA 66 V-0	8560604701	
		x		PA 66 V-0	8560605701	
		x		PA 66 V-0	8560606701	

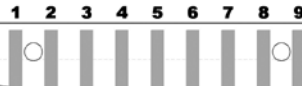

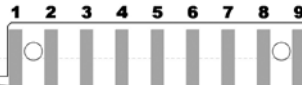

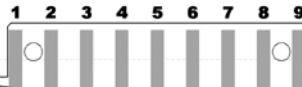

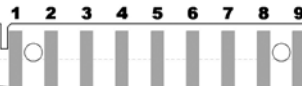



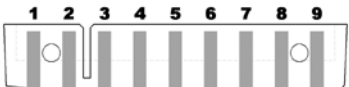

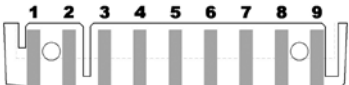

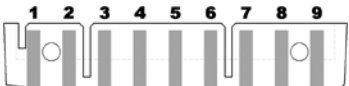

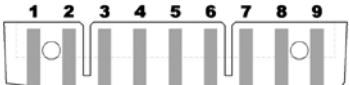

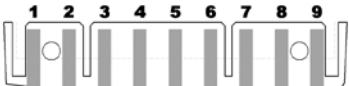

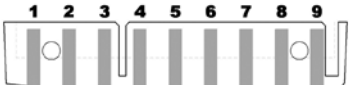

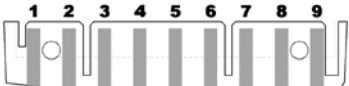

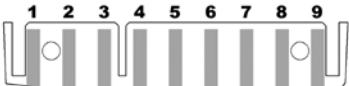

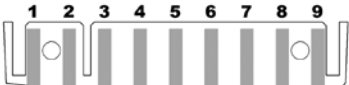

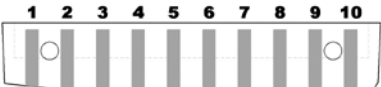
Segue • Follow ➤

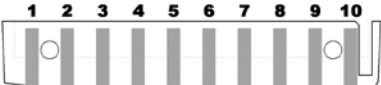
Layout	Schema Pc board layout	Bobina Reel	Catena Chain	Materiale Material	Articolo N° P.N.	Note Notes
		x		PA 66 V-0	8560607701	
		x		PA 66 V-0	8560608701	
		x		PA 66 V-0	8560609701	
		x		PA 66 V-0	8560610701	
		x		PA 66 V-0	8560611701	
		x		PA 66 V-0	8560612701	
		x		PA 66 V-0	8560703701	
		x		PA 66 V-0	8560704701	
		x		PA 66 V-0	8560705701	
		x		PA 66 V-0	8560706701	
		x		PA 66 V-0	8560707701	
		x		PA 66 V-0	8560709701	
		x		PA 66 V-0	8560710701	
		x		PA 66 V-0	8560712701	
		x		PA 66 V-0	8560713701	

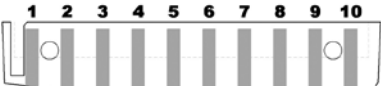
Segue • Follow ➔

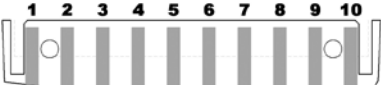
Layout	Schema Pc board layout	Bobina Reel	Catena Chain	Materiale Material	Articolo N° P.N.	Note Notes
		x		PA 66 V-0	8560714701	
		x		PA 66 V-0	8560803701	
		x		PA 66 V-0	8560804701	
		x		PA 66 V-0	8560805701	
		x		PA 66 V-0	8560806701	
		x		PA 66 V-0	8560807701	
		x		PA 66 V-0	8560808701	
		x		PA 66 V-0	8560809701	
		x		PA 66 V-0	8560810701	
		x		PA 66 V-0	8560811701	
		x		PA 66 V-0	8560903701	
		x		PA 66 V-0	8560904701	
		x		PA 66 V-0	8560905701	
		x		PA 66 V-0	8560906701	
		x		PA 66 V-0	8560907701	

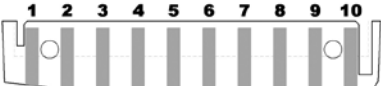

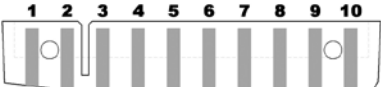







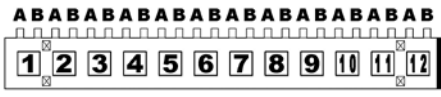
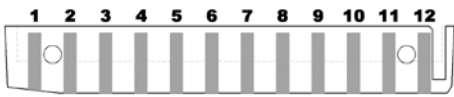
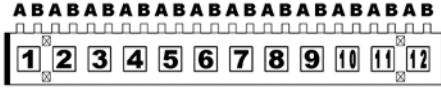
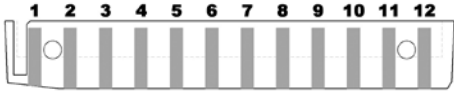

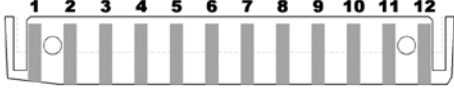
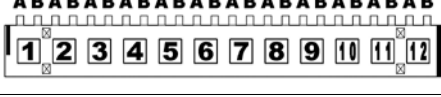

Segue • Follow ➤

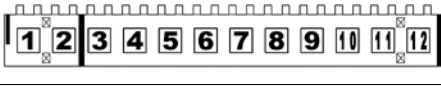
Layout	Schema Pc board layout	Bobina Reel	Catena Chain	Materiale Material	Articolo N° P.N.	Note Notes
		x		PA 66 V-0	8560908701	
		x		PA 66 V-0	8560909701	
		x		PA 66 V-0	8560910701	
		x		PA 66 V-0	8560911701	
		x		PA 66 V-0	8560912701	
		x		PA 66 V-0	8560913701	
		x		PA 66 V-0	8560914701	
		x		PA 66 V-0	8560915701	
		x		PA 66 V-0	8560917701	
		x		PA 66 V-0	8561003701	
		x		PA 66 V-0	8561004701	
		x		PA 66 V-0	8561005701	
		x		PA 66 V-0	8561006701	
		x		PA 66 V-0	8561007701	
		x		PA 66 V-0	8561008701	

Segue • Follow ➔

Layout	Schema Pc board layout	Bobina Reel	Catena Chain	Materiale Material	Articolo N° P.N.	Note Notes
		x		PA 66 V-0	8561009701	
		x		PA 66 V-0	8561010701	
		x		PA 66 V-0	8561011701	
		x		PA 66 V-0	8561012701	
		x		PA 66 V-0	8561013701	
		x		PA 66 V-0	8561103701	
		x		PA 66 V-0	8561104701	
		x		PA 66 V-0	8561105701	
		x		PA 66 V-0	8561106701	
		x		PA 66 V-0	8561107701	
		x		PA 66 V-0	8561108701	
		x		PA 66 V-0	8561109701	
		x		PA 66 V-0	8561110701	
		x		PA 66 V-0	8561111701	
		x		PA 66 V-0	8561203701	

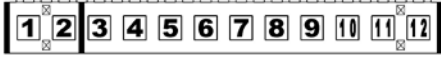
Segue • Follow ➤

Layout	Schema Pc board layout	Bobina Reel	Catena Chain	Materiale Material	Articolo N° P.N.	Note Notes
		x		PA 66 V-0	8561204701	
		x		PA 66 V-0	8561205701	
		x		PA 66 V-0	8561206701	
		x		PA 66 V-0	8561207701	
		x		PA 66 V-0	8561208701	
		x		PA 66 V-0	8561209701	
		x		PA 66 V-0	8561210701	
		x		PA 66 V-0	8561211701	[R]
		x		PA 66 V-0	8561212701	[R]

[R] Senza scarico per aggancio.

[R] Without slit for lock

G2

INAR-IDC RAST 5 Connector system

INAR-IDC CONNETTORI RAST 5 TC
INAR-IDC CONNECTORS RAST 5 TC

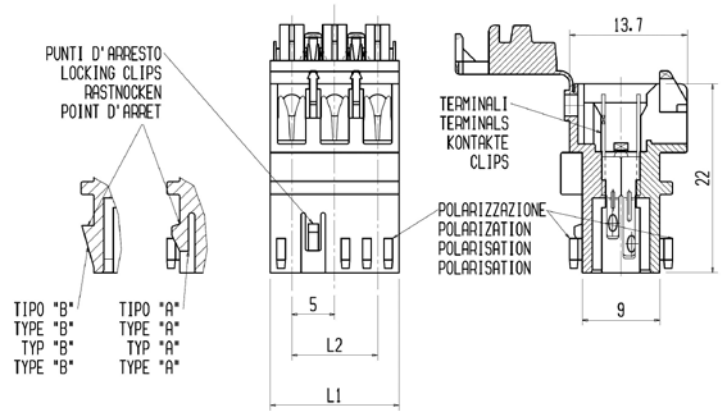

Sez. cavo Wire size (mm ²) (AWG 22 ÷ 17)	Isolante Insulation (mm)	Schema Pc board layout	EXT	INT	Materiale Material	Articolo N° P.N.	Note Notes
0,35 ÷ 1 (AWG 22 ÷ 17)	1,4 ÷ 2,8			x	PA 66 V-0	8550200706A	
0,35 ÷ 1 (AWG 22 ÷ 17)	1,4 ÷ 2,8		x		PA 66 V-0	8550203706A	
0,35 ÷ 1 (AWG 22 ÷ 17)	1,4 ÷ 2,8			x	PA 66 V-0	8550300706A	
0,35 ÷ 1 (AWG 22 ÷ 17)	1,4 ÷ 2,8			x	PA 66 V-0	8550303706A	
0,35 ÷ 1 (AWG 22 ÷ 17)	1,4 ÷ 2,8		x		PA 66 V-0	8550308796A	
0,35 ÷ 1 (AWG 22 ÷ 17)	1,4 ÷ 2,8		x		PA 66 V-0	8550309706A	
0,35 ÷ 1 (AWG 22 ÷ 17)	1,4 ÷ 2,8			x	PA 66 V-0	8550313706A	
0,35 ÷ 1 (AWG 22 ÷ 17)	1,4 ÷ 2,8			x	PA 66 V-0	8550400706A	
0,35 ÷ 1 (AWG 22 ÷ 17)	1,4 ÷ 2,8			x	PA 66 V-0	8550403706A	
0,35 ÷ 1 (AWG 22 ÷ 17)	1,4 ÷ 2,8		x		PA 66 V-0	8550406706A	

Segue • Follow ➤

Sez. cavo Wire size (mm ²)	Isolante Insulation (mm)	Schema Pc board layout	EXT	INT	Materiale Material	Articolo N° P.N.	Note Notes
0,35 ÷ 1 (AWG 22 ÷ 17)	1,4 ÷ 2,8			x	PA 66 V-0	8550500706A	
0,35 ÷ 1 (AWG 22 ÷ 17)	1,4 ÷ 2,8			x	PA 66 V-0	8550502706A	
0,35 ÷ 1 (AWG 22 ÷ 17)	1,4 ÷ 2,8			x	PA 66 V-0	8550504706A	
0,35 ÷ 1 (AWG 22 ÷ 17)	1,4 ÷ 2,8		x		PA 66 V-0	8550506706A	
0,35 ÷ 1 (AWG 22 ÷ 17)	1,4 ÷ 2,8			x	PA 66 V-0	8550508706A	
0,35 ÷ 1 (AWG 22 ÷ 17)	1,4 ÷ 2,8			x	PA 66 V-0	8550511706A	
0,35 ÷ 1 (AWG 22 ÷ 17)	1,4 ÷ 2,8			x	PA 66 V-0	8550512706A	
0,35 ÷ 1 (AWG 22 ÷ 17)	1,4 ÷ 2,8		x		PA 66 V-0	8550513706A	
0,35 ÷ 1 (AWG 22 ÷ 17)	1,4 ÷ 2,8			x	PA 66 V-0	8550514706A	
0,35 ÷ 1 (AWG 22 ÷ 17)	1,4 ÷ 2,8			x	PA 66 V-0	8550600706A	
0,35 ÷ 1 (AWG 22 ÷ 17)	1,4 ÷ 2,8			x	PA 66 V-0	8550602706A	
0,35 ÷ 1 (AWG 22 ÷ 17)	1,4 ÷ 2,8			x	PA 66 V-0	8550604706A	
0,35 ÷ 1 (AWG 22 ÷ 17)	1,4 ÷ 2,8		x		PA 66 V-0	8550606706A	
0,35 ÷ 1 (AWG 22 ÷ 17)	1,4 ÷ 2,8			x	PA 66 V-0	8550608706A	
0,35 ÷ 1 (AWG 22 ÷ 17)	1,4 ÷ 2,8			x	PA 66 V-0	8550610706A	

Segue • Follow ➔

Sez. cavo Wire size (mm ²)	Isolante Insulation (mm)	Schema Pc board layout	EXT	INT	Materiale Material	Articolo N° P.N.	Note Notes
0,35 ÷ 1 (AWG 22 ÷ 17)	1,4 ÷ 2,8			x	PA 66 V-0	8550611706A	
0,35 ÷ 1 (AWG 22 ÷ 17)	1,4 ÷ 2,8		x		PA 66 V-0	8550612706A	
0,35 ÷ 1 (AWG 22 ÷ 17)	1,4 ÷ 2,8		x		PA 66 V-0	8550613706A	
0,35 ÷ 1 (AWG 22 ÷ 17)	1,4 ÷ 2,8			x	PA 66 V-0	8550700706A	
0,35 ÷ 1 (AWG 22 ÷ 17)	1,4 ÷ 2,8		x		PA 66 V-0	8550705706A	
0,35 ÷ 1 (AWG 22 ÷ 17)	1,4 ÷ 2,8		x		PA 66 V-0	8550706706A	
0,35 ÷ 1 (AWG 22 ÷ 17)	1,4 ÷ 2,8			x	PA 66 V-0	8550707706A	
0,35 ÷ 1 (AWG 22 ÷ 17)	1,4 ÷ 2,8			x	PA 66 V-0	8550708706A	
0,35 ÷ 1 (AWG 22 ÷ 17)	1,4 ÷ 2,8			x	PA 66 V-0	8550709706A	
0,35 ÷ 1 (AWG 22 ÷ 17)	1,4 ÷ 2,8			x	PA 66 V-0	8550710706A	
0,35 ÷ 1 (AWG 22 ÷ 17)	1,4 ÷ 2,8			x	PA 66 V-0	8550711706A	
0,35 ÷ 1 (AWG 22 ÷ 17)	1,4 ÷ 2,8			x	PA 66 V-0	8550800706A	
0,35 ÷ 1 (AWG 22 ÷ 17)	1,4 ÷ 2,8			x	PA 66 V-0	8550802706A	
0,35 ÷ 1 (AWG 22 ÷ 17)	1,4 ÷ 2,8		x		PA 66 V-0	8550804706A	
0,35 ÷ 1 (AWG 22 ÷ 17)	1,4 ÷ 2,8		x		PA 66 V-0	8550805706A	

Segue • Follow ➔

Sez. cavo Wire size (mm ²)	Isolante Insulation (mm)	Schema Pc board layout	EXT	INT	Materiale Material	Articolo N° P.N.	Note Notes
0,35 ÷ 1 (AWG 22 ÷ 17)	1,4 ÷ 2,8		x		PA 66 V-0	8550806706A	
0,35 ÷ 1 (AWG 22 ÷ 17)	1,4 ÷ 2,8		x		PA 66 V-0	8550807706A	
0,35 ÷ 1 (AWG 22 ÷ 17)	1,4 ÷ 2,8			x	PA 66 V-0	8550900706A	
0,35 ÷ 1 (AWG 22 ÷ 17)	1,4 ÷ 2,8			x	PA 66 V-0	8550902706A	
0,35 ÷ 1 (AWG 22 ÷ 17)	1,4 ÷ 2,8			x	PA 66 V-0	8550904706A	
0,35 ÷ 1 (AWG 22 ÷ 17)	1,4 ÷ 2,8			x	PA 66 V-0	8550906706A	
0,35 ÷ 1 (AWG 22 ÷ 17)	1,4 ÷ 2,8			x	PA 66 V-0	8551000706A	
0,35 ÷ 1 (AWG 22 ÷ 17)	1,4 ÷ 2,8			x	PA 66 V-0	8551003706A	
0,35 ÷ 1 (AWG 22 ÷ 17)	1,4 ÷ 2,8			x	PA 66 V-0	8551004706A	
1 ÷ 1,5 (AWG 17 ÷ 15)	2,8 ÷ 3			x	PA 66 V-0	8550202796A	
1 ÷ 1,5 (AWG 17 ÷ 15)	2,8 ÷ 3		x		PA 66 V-0	8550205796A	
1 ÷ 1,5 (AWG 17 ÷ 15)	2,8 ÷ 3			x	PA 66 V-0	8550302796A	
1 ÷ 1,5 (AWG 17 ÷ 15)	2,8 ÷ 3			x	PA 66 V-0	8550305796A	
1 ÷ 1,5 (AWG 17 ÷ 15)	2,8 ÷ 3		x		PA 66 V-0	8550307706A	
1 ÷ 1,5 (AWG 17 ÷ 15)	2,8 ÷ 3		x		PA 66 V-0	8550308796A	

Segue • Follow ➔

Sez. cavo Wire size (mm ²)	Isolante Insulation (mm)	Schema Pc board layout	EXT	INT	Materiale Material	Articolo N° P.N.	Note Notes
1 ÷ 1,5 (AWG 17 ÷ 15)	2,8 ÷ 3		x		PA 66 V-0	8550311796A	
1 ÷ 1,5 (AWG 17 ÷ 15)	2,8 ÷ 3			x	PA 66 V-0	8550402796A	
1 ÷ 1,5 (AWG 17 ÷ 15)	2,8 ÷ 3			x	PA 66 V-0	8550405796A	
1 ÷ 1,5 (AWG 17 ÷ 15)	2,8 ÷ 3		x		PA 66 V-0	8550408796A	
1 ÷ 1,5 (AWG 17 ÷ 15)	2,8 ÷ 3		x		PA 66 V-0	8550410796A	
1 ÷ 1,5 (AWG 17 ÷ 15)	2,8 ÷ 3			x	PA 66 V-0	8550510796A	
1 ÷ 1,5 (AWG 17 ÷ 15)	2,8 ÷ 3			x	PA 66 V-0	8550503706A	

INAR-IDC CONNETTORI RAST 5 PCB
INAR-IDC CONNECTORS RAST 5 PCB

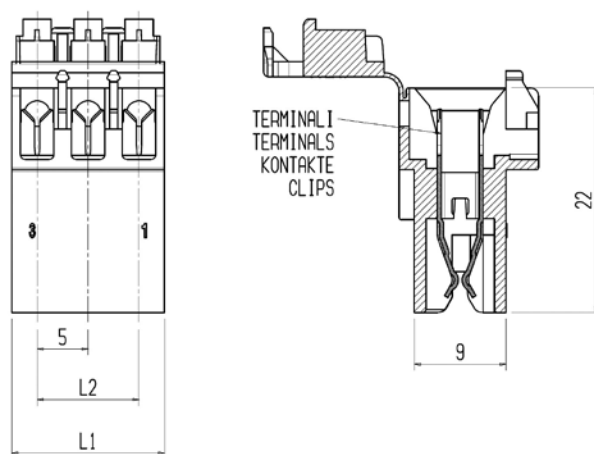









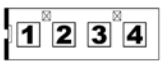
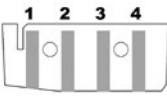
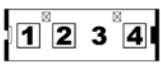
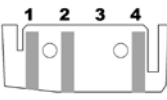

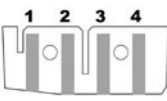
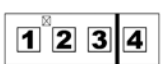
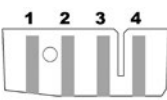
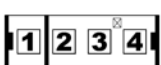
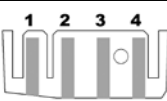
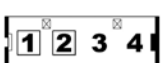
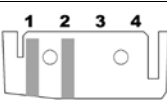
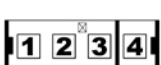
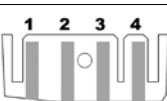
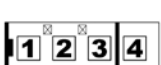
Sez. cavo Wire size (mm ²)	Layout	Schema Pc board layout	Materiale Material	Articolo N° P.N.	Note Notes
0,35 ÷ 0,75 (AWG 22 ÷ 18)			PA 66 V-0	8580203706	
0,35 ÷ 0,75 (AWG 22 ÷ 18)			PA 66 V-0	8580204706	
0,35 ÷ 0,75 (AWG 22 ÷ 18)			PA 66 V-0	8580205706	
0,35 ÷ 0,75 (AWG 22 ÷ 18)			PA 66 V-0	8580206706	
0,35 ÷ 0,75 (AWG 22 ÷ 18)			PA 66 V-0	8580207706	
0,35 ÷ 0,75 (AWG 22 ÷ 18)			PA 66 V-0	8580208706	
0,35 ÷ 0,75 (AWG 22 ÷ 18)			PA 66 V-0	8580209706	
0,35 ÷ 0,75 (AWG 22 ÷ 18)			PA 66 V-0	8580210706	
0,35 ÷ 0,75 (AWG 22 ÷ 18)			PA 66 V-0	8580211706	
0,35 ÷ 0,75 (AWG 22 ÷ 18)			PA 66 V-0	8580303706	

Segue • Follow ➤

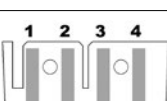
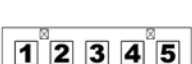

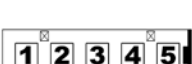
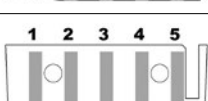
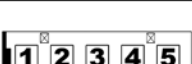
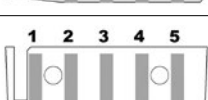
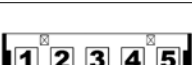

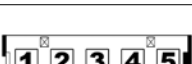
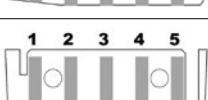





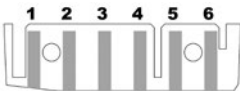

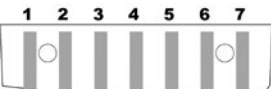
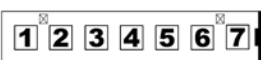
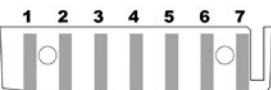
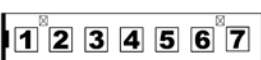

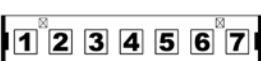
Sez. cavo Wire size (mm ²)	Layout	Schema Pc board layout	Materiale Material	Articolo N° P.N.	Note Notes
0,35 ÷ 0,75 (AWG 22 ÷ 18)			PA 66 V-0	8580304706	
0,35 ÷ 0,75 (AWG 22 ÷ 18)			PA 66 V-0	8580305706	
0,35 ÷ 0,75 (AWG 22 ÷ 18)			PA 66 V-0	8580306706	
0,35 ÷ 0,75 (AWG 22 ÷ 18)			PA 66 V-0	8580307706	
0,35 ÷ 0,75 (AWG 22 ÷ 18)			PA 66 V-0	8580308706	
0,35 ÷ 0,75 (AWG 22 ÷ 18)			PA 66 V-0	8580309706	
0,35 ÷ 0,75 (AWG 22 ÷ 18)			PA 66 V-0	8580310706	
0,35 ÷ 0,75 (AWG 22 ÷ 18)			PA 66 V-0	8580311706	
0,35 ÷ 0,75 (AWG 22 ÷ 18)			PA 66 V-0	8580403706	
0,35 ÷ 0,75 (AWG 22 ÷ 18)			PA 66 V-0	8580404706	
0,35 ÷ 0,75 (AWG 22 ÷ 18)			PA 66 V-0	8580405706	
0,35 ÷ 0,75 (AWG 22 ÷ 18)			PA 66 V-0	8580406706	
0,35 ÷ 0,75 (AWG 22 ÷ 18)			PA 66 V-0	8580407706	
0,35 ÷ 0,75 (AWG 22 ÷ 18)			PA 66 V-0	8580408706	
0,35 ÷ 0,75 (AWG 22 ÷ 18)			PA 66 V-0	8580409706	

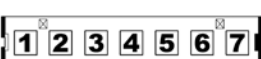
Segue • Follow ➤

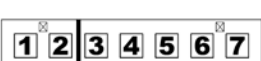
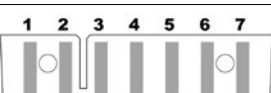
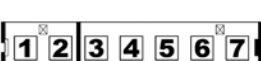
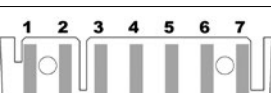
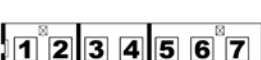
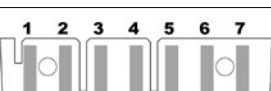
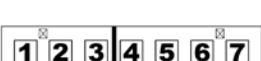
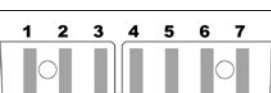
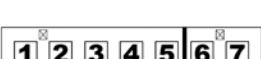

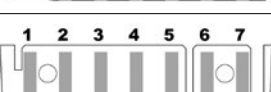

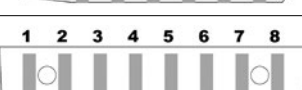
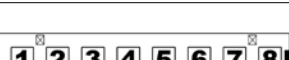

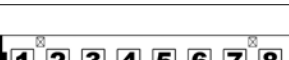
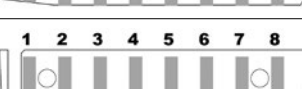



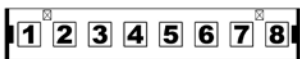
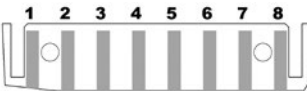
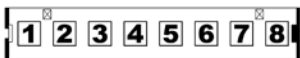
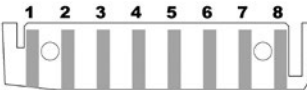
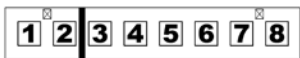
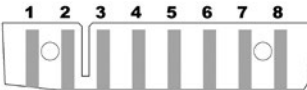
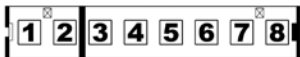

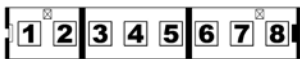
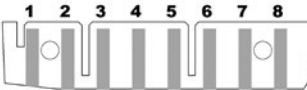
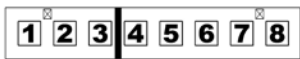
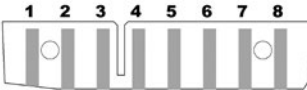

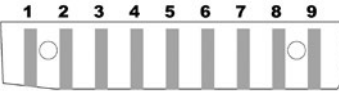

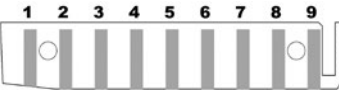

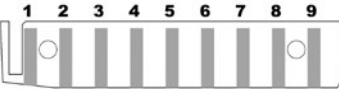

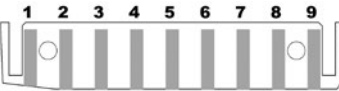
Sez. cavo Wire size (mm ²)	Layout	Schema Pc board layout	Materiale Material	Articolo N° P.N.	Note Notes
0,35 ÷ 0,75 (AWG 22 ÷ 18)			PA 66 V-0	8580410706	
0,35 ÷ 0,75 (AWG 22 ÷ 18)			PA 66 V-0	8580411706	
0,35 ÷ 0,75 (AWG 22 ÷ 18)			PA 66 V-0	8580412706	
0,35 ÷ 0,75 (AWG 22 ÷ 18)			PA 66 V-0	8580413706	
0,35 ÷ 0,75 (AWG 22 ÷ 18)			PA 66 V-0	8580414706	
0,35 ÷ 0,75 (AWG 22 ÷ 18)			PA 66 V-0	8580415706	
0,35 ÷ 0,75 (AWG 22 ÷ 18)			PA 66 V-0	8580416706	
0,35 ÷ 0,75 (AWG 22 ÷ 18)			PA 66 V-0	8580417706	
0,35 ÷ 0,75 (AWG 22 ÷ 18)			PA 66 V-0	8580418706	
0,35 ÷ 0,75 (AWG 22 ÷ 18)			PA 66 V-0	8580419706	
0,35 ÷ 0,75 (AWG 22 ÷ 18)			PA 66 V-0	8580503706	
0,35 ÷ 0,75 (AWG 22 ÷ 18)			PA 66 V-0	8580504706	
0,35 ÷ 0,75 (AWG 22 ÷ 18)			PA 66 V-0	8580505706	
0,35 ÷ 0,75 (AWG 22 ÷ 18)			PA 66 V-0	8580506706	
0,35 ÷ 0,75 (AWG 22 ÷ 18)			PA 66 V-0	8580507706	

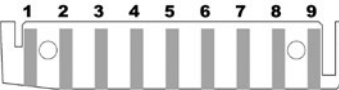
Segue • Follow ➔

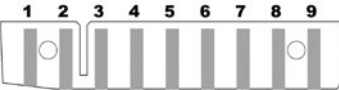
Sez. cavo Wire size (mm ²)	Layout	Schema Pc board layout	Materiale Material	Articolo N° P.N.	Note Notes
0,35 ÷ 0,75 (AWG 22 ÷ 18)			PA 66 V-0	8580508706	
0,35 ÷ 0,75 (AWG 22 ÷ 18)			PA 66 V-0	8580509706	
0,35 ÷ 0,75 (AWG 22 ÷ 18)			PA 66 V-0	8580510706	
0,35 ÷ 0,75 (AWG 22 ÷ 18)			PA 66 V-0	8580511706	
0,35 ÷ 0,75 (AWG 22 ÷ 18)			PA 66 V-0	8580512706	
0,35 ÷ 0,75 (AWG 22 ÷ 18)			PA 66 V-0	8580603706	
0,35 ÷ 0,75 (AWG 22 ÷ 18)			PA 66 V-0	8580604706	
0,35 ÷ 0,75 (AWG 22 ÷ 18)			PA 66 V-0	8580605706	
0,35 ÷ 0,75 (AWG 22 ÷ 18)			PA 66 V-0	8580606706	
0,35 ÷ 0,75 (AWG 22 ÷ 18)			PA 66 V-0	8580607706	
0,35 ÷ 0,75 (AWG 22 ÷ 18)			PA 66 V-0	8580608706	
0,35 ÷ 0,75 (AWG 22 ÷ 18)			PA 66 V-0	8580609706	
0,35 ÷ 0,75 (AWG 22 ÷ 18)			PA 66 V-0	8580610706	
0,35 ÷ 0,75 (AWG 22 ÷ 18)			PA 66 V-0	8580611706	
0,35 ÷ 0,75 (AWG 22 ÷ 18)			PA 66 V-0	8580612706	

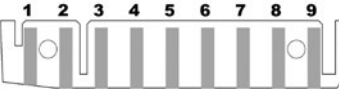
Sez. cavo Wire size (mm ²)	Layout	Schema Pc board layout	Materiale Material	Articolo N° P.N.	Note Notes
0,35 ÷ 0,75 (AWG 22 ÷ 18)			PA 66 V-0	8580613706	
0,35 ÷ 0,75 (AWG 22 ÷ 18)			PA 66 V-0	8580703706	
0,35 ÷ 0,75 (AWG 22 ÷ 18)			PA 66 V-0	8580704706	
0,35 ÷ 0,75 (AWG 22 ÷ 18)			PA 66 V-0	8580705706	
0,35 ÷ 0,75 (AWG 22 ÷ 18)			PA 66 V-0	8580706706	
0,35 ÷ 0,75 (AWG 22 ÷ 18)			PA 66 V-0	8580707706	
0,35 ÷ 0,75 (AWG 22 ÷ 18)			PA 66 V-0	8580708706	
0,35 ÷ 0,75 (AWG 22 ÷ 18)			PA 66 V-0	8580709706	
0,35 ÷ 0,75 (AWG 22 ÷ 18)			PA 66 V-0	8580710706	
0,35 ÷ 0,75 (AWG 22 ÷ 18)			PA 66 V-0	8580712706	
0,35 ÷ 0,75 (AWG 22 ÷ 18)			PA 66 V-0	8580713706	
0,35 ÷ 0,75 (AWG 22 ÷ 18)			PA 66 V-0	8580714706	
0,35 ÷ 0,75 (AWG 22 ÷ 18)			PA 66 V-0	8580803706	
0,35 ÷ 0,75 (AWG 22 ÷ 18)			PA 66 V-0	8580804706	
0,35 ÷ 0,75 (AWG 22 ÷ 18)			PA 66 V-0	8580805706	

Segue • Follow ➔

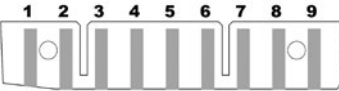
Sez. cavo Wire size (mm ²)	Layout	Schema Pc board layout	Materiale Material	Articolo N° P.N.	Note Notes
0,35 ÷ 0,75 (AWG 22 ÷ 18)			PA 66 V-0	8580806706	
0,35 ÷ 0,75 (AWG 22 ÷ 18)			PA 66 V-0	8580807706	
0,35 ÷ 0,75 (AWG 22 ÷ 18)			PA 66 V-0	8580808706	
0,35 ÷ 0,75 (AWG 22 ÷ 18)			PA 66 V-0	8580809706	
0,35 ÷ 0,75 (AWG 22 ÷ 18)			PA 66 V-0	8580810706	
0,35 ÷ 0,75 (AWG 22 ÷ 18)			PA 66 V-0	8580811706	
0,35 ÷ 0,75 (AWG 22 ÷ 18)			PA 66 V-0	8580903706	
0,35 ÷ 0,75 (AWG 22 ÷ 18)			PA 66 V-0	8580904706	
0,35 ÷ 0,75 (AWG 22 ÷ 18)			PA 66 V-0	8580905706	
0,35 ÷ 0,75 (AWG 22 ÷ 18)			PA 66 V-0	8580906706	
0,35 ÷ 0,75 (AWG 22 ÷ 18)			PA 66 V-0	8580907706	
0,35 ÷ 0,75 (AWG 22 ÷ 18)			PA 66 V-0	8580908706	
0,35 ÷ 0,75 (AWG 22 ÷ 18)			PA 66 V-0	8580909706	
0,35 ÷ 0,75 (AWG 22 ÷ 18)			PA 66 V-0	8580910706	
0,35 ÷ 0,75 (AWG 22 ÷ 18)			PA 66 V-0	8580911706	







Segue • Follow ➤

Sez. cavo Wire size (mm ²)	Layout	Schema Pc board layout	Materiale Material	Articolo N° P.N.	Note Notes
0,35 ÷ 0,75 (AWG 22 ÷ 18)			PA 66 V-0	8580912706	
0,35 ÷ 0,75 (AWG 22 ÷ 18)			PA 66 V-0	8580913706	
0,35 ÷ 0,75 (AWG 22 ÷ 18)			PA 66 V-0	8580914706	
0,35 ÷ 0,75 (AWG 22 ÷ 18)			PA 66 V-0	8580915706	
0,35 ÷ 0,75 (AWG 22 ÷ 18)			PA 66 V-0	8580916706	
0,35 ÷ 0,75 (AWG 22 ÷ 18)			PA 66 V-0	8581003706	
0,35 ÷ 0,75 (AWG 22 ÷ 18)			PA 66 V-0	8581004706	
0,35 ÷ 0,75 (AWG 22 ÷ 18)			PA 66 V-0	8581005706	
0,35 ÷ 0,75 (AWG 22 ÷ 18)			PA 66 V-0	8581006706	
0,35 ÷ 0,75 (AWG 22 ÷ 18)			PA 66 V-0	8581007706	
0,35 ÷ 0,75 (AWG 22 ÷ 18)			PA 66 V-0	8581008706	
0,35 ÷ 0,75 (AWG 22 ÷ 18)			PA 66 V-0	8581009706	
0,35 ÷ 0,75 (AWG 22 ÷ 18)			PA 66 V-0	8581010706	
0,35 ÷ 0,75 (AWG 22 ÷ 18)			PA 66 V-0	8581011706	
0,35 ÷ 0,75 (AWG 22 ÷ 18)			PA 66 V-0	8581012706	

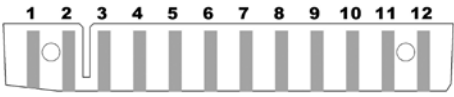
Segue • Follow ➔

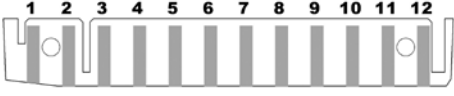
Sez. cavo Wire size (mm ²)	Layout	Schema Pc board layout	Materiale Material	Articolo N° P.N.	Note Notes
0,35 ÷ 0,75 (AWG 22 ÷ 18)			PA 66 V-0	8581013706	
0,35 ÷ 0,75 (AWG 22 ÷ 18)			PA 66 V-0	8581103706	
0,35 ÷ 0,75 (AWG 22 ÷ 18)			PA 66 V-0	8581104706	
0,35 ÷ 0,75 (AWG 22 ÷ 18)			PA 66 V-0	8581105706	
0,35 ÷ 0,75 (AWG 22 ÷ 18)			PA 66 V-0	8581106706	
0,35 ÷ 0,75 (AWG 22 ÷ 18)			PA 66 V-0	8581107706	
0,35 ÷ 0,75 (AWG 22 ÷ 18)			PA 66 V-0	8581108706	
0,35 ÷ 0,75 (AWG 22 ÷ 18)			PA 66 V-0	8581109706	
0,35 ÷ 0,75 (AWG 22 ÷ 18)			PA 66 V-0	8581110706	
0,35 ÷ 0,75 (AWG 22 ÷ 18)			PA 66 V-0	8581111706	
0,35 ÷ 0,75 (AWG 22 ÷ 18)			PA 66 V-0	8581203706	
0,35 ÷ 0,75 (AWG 22 ÷ 18)			PA 66 V-0	8581204706	
0,35 ÷ 0,75 (AWG 22 ÷ 18)			PA 66 V-0	8581205706	
0,35 ÷ 0,75 (AWG 22 ÷ 18)			PA 66 V-0	8581206706	
0,35 ÷ 0,75 (AWG 22 ÷ 18)			PA 66 V-0	8581207706	

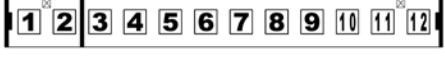
Segue • Follow ➔

Sez. cavo Wire size (mm ²)	Layout	Schema Pc board layout	Materiale Material	Articolo N° P.N.	Note Notes
0,35 ÷ 0,75 (AWG 22 ÷ 18)			PA 66 V-0	8581208706	
0,35 ÷ 0,75 (AWG 22 ÷ 18)			PA 66 V-0	8581209706	
0,35 ÷ 0,75 (AWG 22 ÷ 18)			PA 66 V-0	8581210706	
0,35 ÷ 0,75 (AWG 22 ÷ 18)			PA 66 V-0	8581212706	

M

Tooling volume G

INAR-TOOL MINIAPPLICATORE

I miniapplicatori INAR-TOOL sono frutto della lunga esperienza di Inarca nella costruzione dei terminali. Estrema affidabilità e precisione sono le caratteristiche riconosciute dagli utilizzatori a questi miniapplicatori che sono fornibili dedicati a tutti i terminali presenti sul mercato. I miniapplicatori possono essere ad alimentazione frontale (F) o laterale (S) con regolazione dell'altezza di aggraffatura tramite la ghiera a scatti o micrometrica. Le parti di ricambio sono di grande qualità e lunghissima durata. I miniapplicatori INAR-TOOL sono compatibili con i sistemi automatici di aggraffatura Inarca e con gli altri presenti sul mercato.

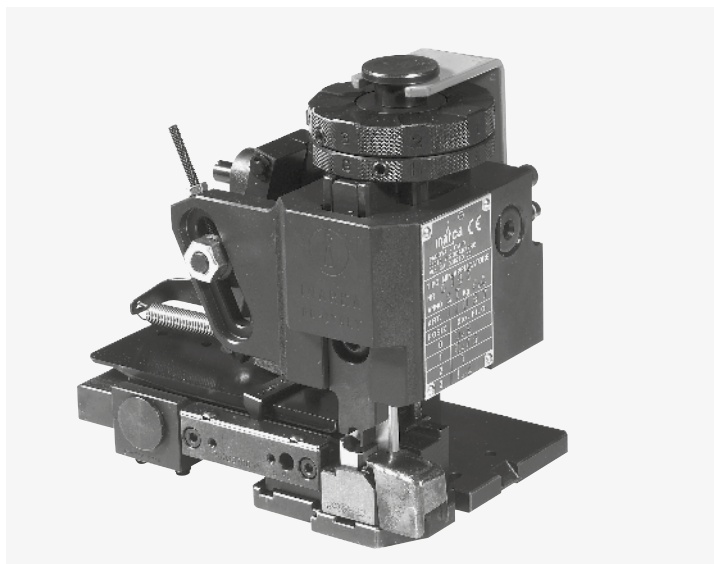

INAR-TOOL S

Versione con regolazione a scatti
Step-by-step setting

INAR-TOOL APPLICATOR

The INAR-TOOL applicators are the result of a long experience made by Inarca in the production of terminals. The very long resistance and precision are the features noticed by the users of these applicators and they can be customized for all types of terminals present on the market. They are available with end-feed or side-feed and the crimping height can be adjusted through a "step-by-step" or a "micrometric" regulating head. The spare parts are of great quality and long resistance. The INAR-TOOL applicators are compatible with Inarca's automatic crimping systems the others present on the market.



INAR-TOOL F

Versione con regolazione micrometrica
Micrometric setting

UTENSILE MANUALE PER ESTRARRE I TERMINALI DELLA SERIE INAR-TC

Estrattori codice: SL111116B500

Consente di rimuovere i terminali della serie INAR-TC dal vano dei connettori INAR-TC.

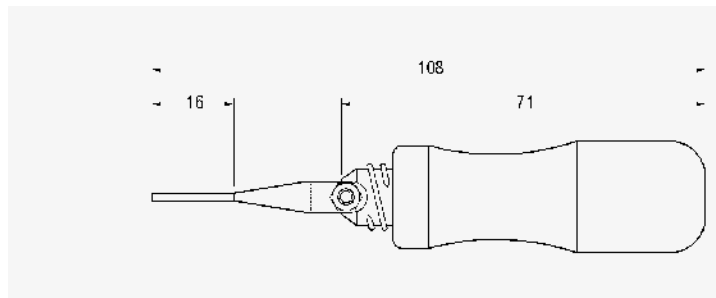

CONTACT EXTRACTION TOOL INAR-TC SERIES TERMINALS

P.N.: SL111116B500

Enable to remove terminal of the INAR-TC series, from all the INAR-TC housings.

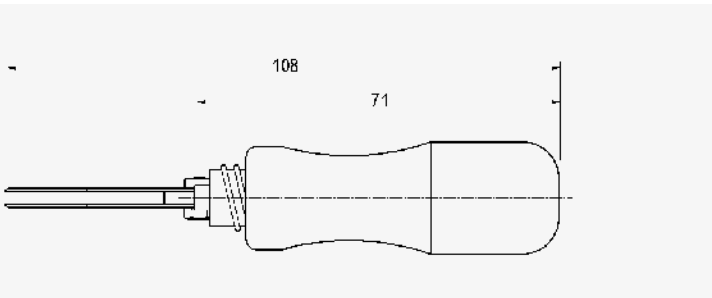

PINZE PER PROCESSARE CONNETTORI INAR-IDC RAST

Le pinze per la serie INAR-IDC RAST sono lo strumento ideale per processare piccoli lotti, per la preparazione di campionature, per le riprese a bordo linea o per il servizio di manutenzione sul campo. Consentono di processare tutti i tipi di connettori INAR-IDC RAST di produzione Inarca senza alcuna regolazione, mentre per la scelta della sezione cavo è sufficiente agire su una ghiera graduata. Il corretto inserimento del filo è garantito dal rispetto del sistema certificato da Inarca per tutte le attrezzature che processano connettori INAR-IDC RAST. Le pinze per processare i connettori Inarca IDC RAST sono disponibili nelle versioni per:

- INAR-IDC RAST 2,5
- INAR-IDC RAST 2,5 ENERGY
- INAR-IDC RAST 5 TC
- INAR-IDC RAST 5 PCB



HAND TOOL FOR INAR-IDC RAST CONNECTOR

The hand tool for INAR-IDC RAST series is capable to applying small quantities, to realize samples, production start-up or prototype. The hand tool process all kind of INAR-IDC RAST connectors without any adjustment. The correct insertion of wire is guaranteed by the Inarca certified system for all the equipment working on INAR-IDC RAST connectors. The Hand Tool for INAR-IDC RAST connector are available in the following version:

- INAR-IDC RAST 2,5
- INAR-IDC RAST 2,5 ENERGY
- INAR-IDC RAST 5 TC
- INAR-IDC RAST 5 PCB



INAR-TOOL IDC MINIAPPLICATORE PER CONNETTORI INAR-IDC RAST

I Miniapplicatori per processare i connettori INAR-IDC RAST sono disponibili nelle versioni per:

- INAR-IDC RAST 2,5
- INAR-IDC RAST 2,5 ENERGY
- INAR-IDC RAST 5 TC
- INAR-IDC RAST 5 PCB

I Miniapplicatori Inarca per i connettori della serie INAR-IDC RAST consentono una produttività paragonabile ai tradizionali miniapplicatori per aggirare. Questi miniapplicatori sono dotati di avanzamento dei pezzi pneumatico e possono essere utilizzati con le principali Presse da Banco previo adattamento delle protezioni alla struttura del mini (Inarca può fornire le presse con la protezione modificata). I miniapplicatori INAR-TOOL IDC consentono di processare tutti i tipi di connettori INAR-IDC RAST di produzione Inarca senza alcuna regolazione, mentre per la scelta della sezione del cavo è sufficiente agire sulla regolazione micrometrica della testina. Il corretto inserimento del filo è garantito dal rispetto del sistema certificato da Inarca per tutte le attrezzature che processano connettori INAR-IDC RAST.

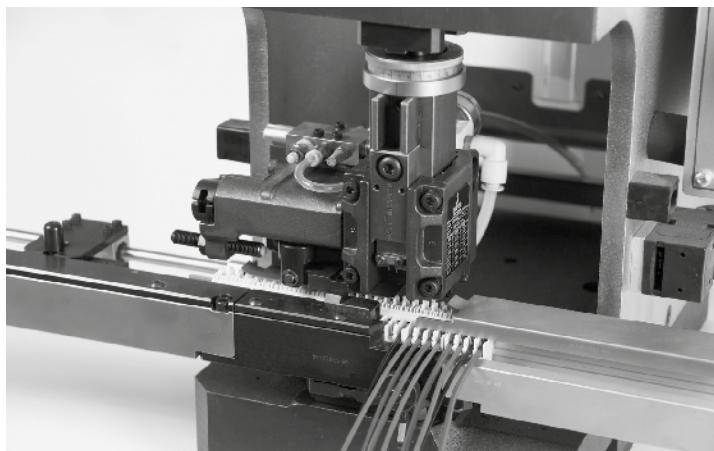

INAR-TOOL IDC APPLICATOR FOR INAR-IDC RAST SERIES

The INAR-TOOL IDC for INAR-IDC RAST connectors are available in four versions:

- INAR-IDC RAST 2,5
- INAR-IDC RAST 2,5 ENERGY
- INAR-IDC RAST 5 TC
- INAR-IDC RAST 5 PCB

The productivity with INAR-TOOL IDC applicators is comparable with traditional crimping INAR-TOOL ones. These applicators have a pneumatic feeding system and can be used in combination with a standard crimping press machine (the safety-protections of the crimping press machine should be adapted on the applicator shape). Inarca can supply the Crimping-Press machines with the modified safety protections. The applicators enable to terminate all version of INAR-IDC RAST connectors without any adjustment. The correct insertion of wire is guaranteed by the Inarca certified system for all the equipment working on INAR-IDC RAST connectors.

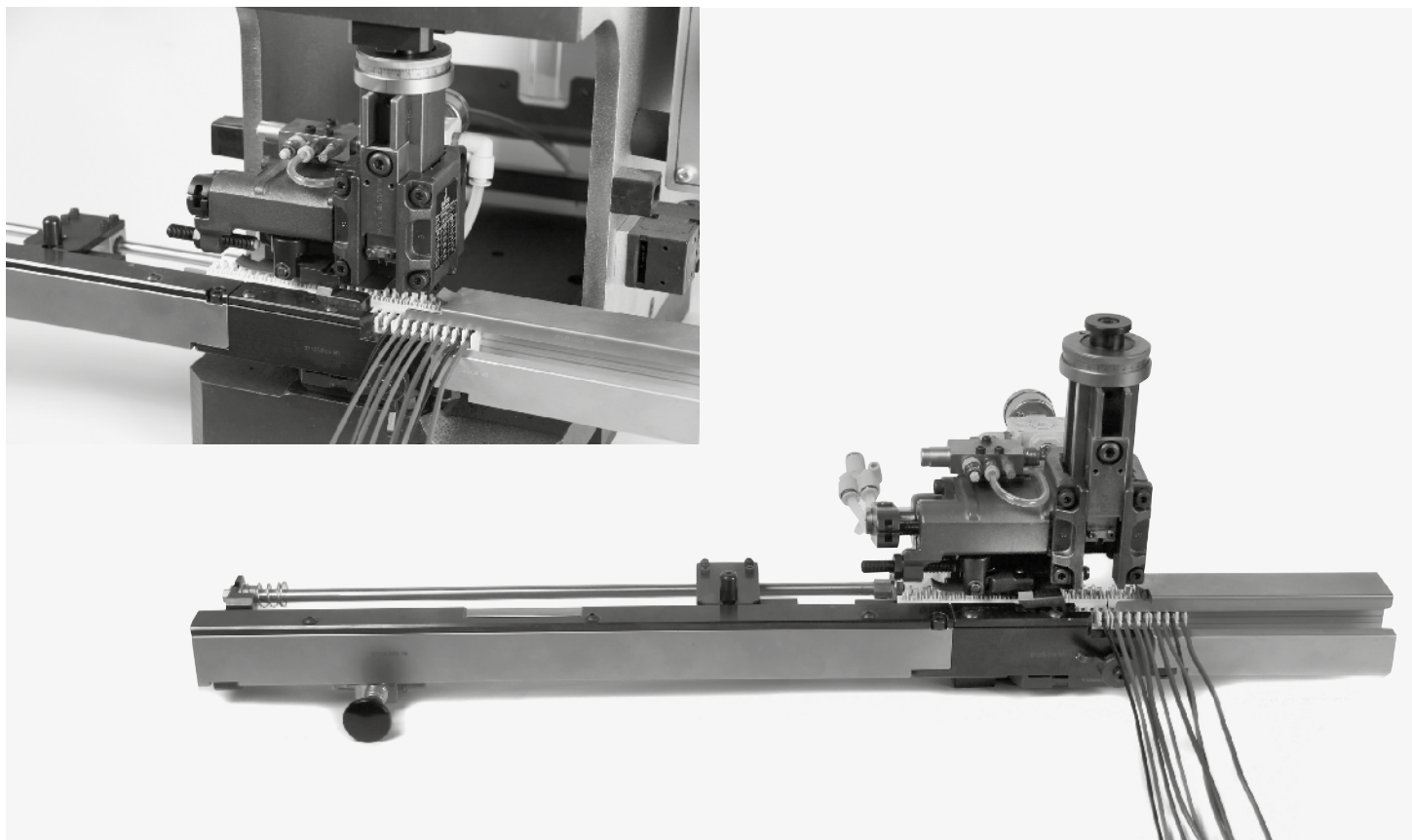

INAR-WBM**MACCHINA PER CONNETTORI INAR-IDC RAST**

Le macchine semiautomatiche della famiglia INAR WBM consentono di processare i connettori Inarca INAR-IDC RAST per la produzione di cablaggi a spostamento di isolante. Le macchine INAR-WBM sono macchine ad alto contenuto tecnologico, che hanno come caratteristiche peculiari un'elevata flessibilità di lavoro e un'alta velocità di produzione.

Caratteristiche tecniche

- Tipologie di connettori processabili:
 - INAR-IDC RAST 2,5 da 3 a 20 vie
 - INAR-IDC RAST 2,5 Energy da 2 a 12 vie
 - INAR-IDC RAST 5 da 2 a 10 vie
 - INAR-IDC RAST 5 PCB da 2 a 12 vie
- Moduli ottenibili: tutte le tipologie. Normale, loop, incrociato, parallelo.
- Lunghezza minima del cavo processabile: 30 mm per connessioni normali, 80mm per connessioni loop.
- Diametro del filo processabile: sezione da 0.22 a 1,5 mm².
- Capacità massima di carico: 20 vie alla volta.
- Caratteristiche programmabili:
 - Sequenza di connessione (salti via).
 - Sequenza di polarizzazione (taglio polarizzatori).
 - Chiusura coperchio connettore.
- Tensione di alimentazione: 220 V (frequenza 50 HZ).
- Pressione pneumatica di alimentazione: 6 bar.
- Possibilità di programmazione da pannello operatore o da un PC esterno (in quest'ultimo caso viene fornito il programma di gestione).
- Possibilità di poter processare un connettore singolo inserito dall'esterno (in caso sia necessario effettuare una lavorazione per ripresa).

INAR-WBM**MACHINE FOR INAR-IDC RAST CONNECTORS SYSTEM**

INAR-WBM is a semiautomatic bench machine to terminate INAR-IDC RAST Connector System series. It is a machine with a high technological level, it is very flexible and it has a high production speed.

Technical features

- Connectors type processable:
 - INAR-IDC RAST 2,5 from 3 to 20 ways
 - INAR-RAST 2,5 Energy from 2 to 12 ways
 - INAR-RAST 5 from 2 to 10 ways
 - INAR-RAST 5 PCB from 2 to 12 ways
- Harnesses type: Normal, parallel, crossed and loop.
- Minimum length wire: 30 mm for normal harnesses, 80 mm for loop harness.
- Wire Size Range : Section 0.22 up to 1,5 mm².
- Maximum charge capacity: 20 ways per cycle.
- Programmable features:
 - Connection sequence (jump way).
 - Polarization sequence (rib cut).
 - Lockup connector cover.
- Power Supply: 220 V (frequency 50 HZ).
- Air Pressure: 6 bar.
- Panel programming or PC external programming (in this case is included the program).
- It is possible to process a single connector, from outside (when it is necessary to process a secondary operation).

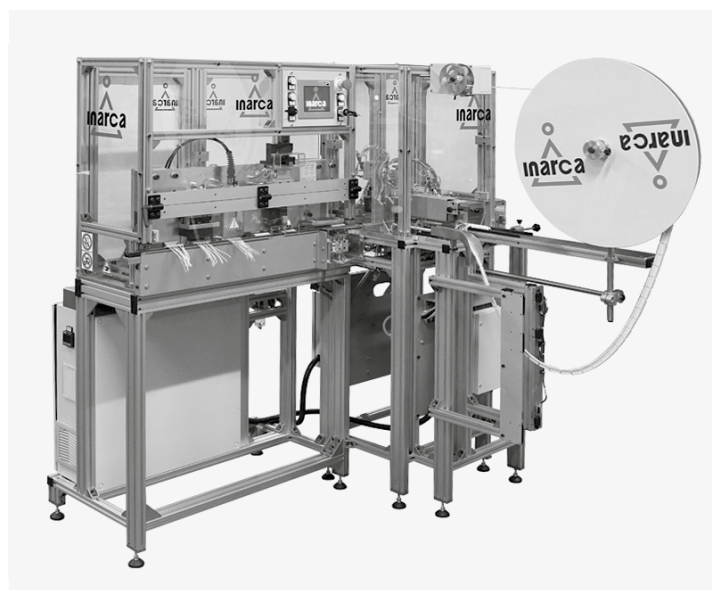

Stazioni di lavoro WBM

A – Stazione di carico connettori:

dove vengono posizionati i connettori da processare.

B – Stazione di avanzamento della catena dei connettori:

è un dispositivo che permette l'avanzamento a passo dei connettori, in modo di poter processare connettori di numero di vie diverse.

C – Stazione di singolarizzazione: è la zona dove i connettori vengono separati dalla catena di alimentazione.

D – Zona di inserimento: è la zona dove vengono inseriti i cavi nel connettore. L'operatore inserisce il cavo in una dima di centraggio, provvista di un dispositivo di antisfilamento del filo, e fino al raggiungimento della posizione ottimale. A questo punto la testina di piantaggio parte automaticamente ed inserisce il cavo nella via. Una volta inserito il cavo il connettore trasla portando in lavorazione la successiva via vuota oppure, se il cablaggio è terminato, portando il connettore nella stazione successiva.

E – Zona di chiusura coperchio: è la zona dove vengono chiusi i coperchi dei connettori. Programmando opportunamente la macchina, tale dispositivo può essere escluso.

F – Zona di polarizzazione: è la zona dove vengono tagliati i dentini di polarizzazione. Fisicamente tale spazio coincide con quello della chiusura dei coperchi. La sequenza di taglio può essere programmata dall'operatore e avviene in contemporanea con l'inserimento dei cavi nel connettore seguente (che si trova nella stazione di inserimento). Finita la lavorazione il connettore viene portato nella posizione di scarico.

G – Zona di scarico: è una zona di parcheggio da cui l'operatore può prelevare i cablaggi finiti.

WBM Workstations

A – Connector loading station.

B – Auto feed of the production chain station: a device permits the auto feed of the production chain, that carries the head connector in the position, where the catenary is separate. Hand acting on a cam with a scale, is it possible to adjust the advancement, so it is easy to process the connectors with a different number of ways.

C – Singularization unit: connectors are separated from the chain.

D – Termination zone: a head inserts the wire into the connector. The operator must insert the wire in a centering template, with a device that holds the wire. Now the insertion head start automatically. Once the wire has been inserted, the connector moves to process the next empty way or, if the harness is complete, the connector moves to the next station.

E – Lockup cover station: where a device close the covers. The machine can be programmed to skip this station.

F – Key Coding zone: a unit cuts the coding ribs. The location is shared with the lockup cover station. The sequence of cutting can be programmed by the operator. When the connector reach the polarization zone, the next connector reach the insertion zone to be harnessed.

G – Discharged zone: the harnesses are stocked in this area and the operator can collect them.

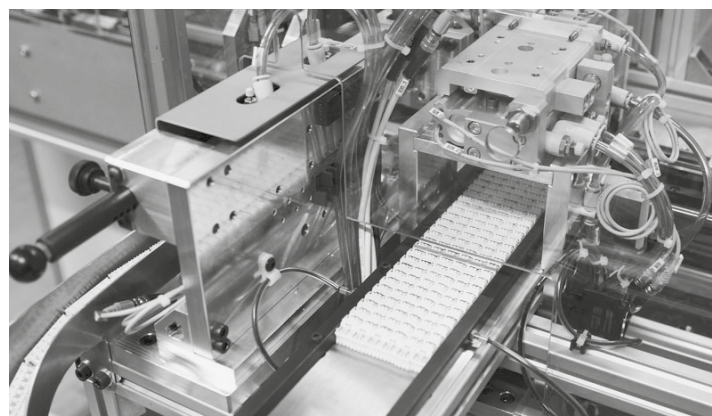
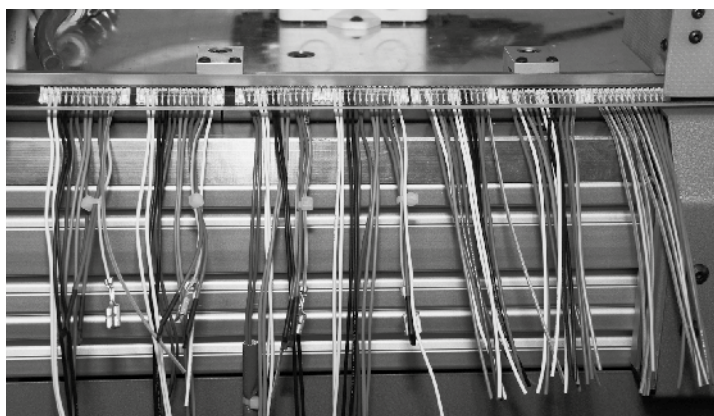
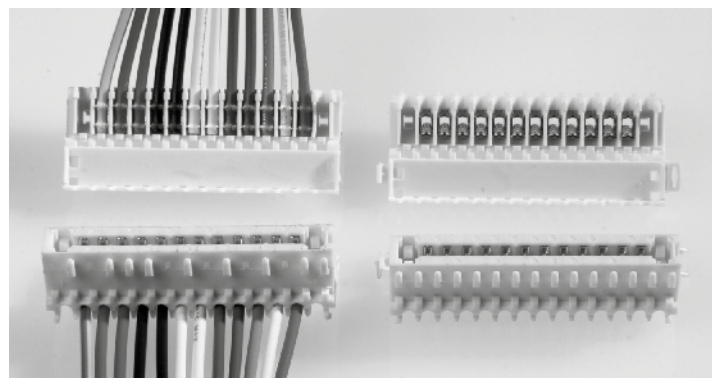

NAR-AHM EVOLUTION MACCHINA AUTOMATICA PER CONNETTORI INARCA IDC RAST

Sistema innovativo di trasferimento prodotto a pallet, consente un allestimento modulare, componibile in funzione delle esigenze. L'utilizzo dei sistemi servomotore per il posizionamento dei pallet permette un preciso posizionamento dei connettori per l'inserimento del cavo, garantendo la qualità richiesta per tale processo. La sua dinamica, insieme al sistema indipendente di alimentazione per singolo cavo, consente di raggiungere prestazioni altamente performanti permettendo produrre cablaggi con ciclo, nella configurazione più completa, di 5,4 sec. a pallet, corrispondenti a circa 8000 cavi/ora. Può essere configurata da min. 2 a max. 12 sistemi di alimentazione cavo per la produzione di moduli di cablaggio con connettori a perforazione di isolante e terminali aggraffati, secondo richieste specifiche. Può eseguire incroci dei conduttori rispetto alle vie adiacenti dei connettori e realizzare configurazioni cablaggio a "Z". Le presse di aggraffatura, se richieste, possono essere dotate (opzionale) con sistemi di misura e controllo della forza di aggraffatura. La macchina può essere allestita con una unità di inserimento capsule (opzionale). Questa unità lavora nel tempo ciclo della macchina. Un dispositivo meccanico (opzionale) di alta precisione può eseguire la polarizzazione di tutti i connettori presenti sul pallet. Si possono adottare (opzionale) dei controlli delle lavorazioni con sistemi a telecamera che garantiscono la qualità del prodotto.

FULLY AUTOMATIC MACHINES SERIES AHM EVOLUTION FOR INARCA IDC RAST CONNECTORS SYSTEM

The pallet based machine allows a modular configuration, being able to process most common types of Inarca IDC connectors available, in accordance with the customer's needs. The use of servo drives to position the pallets allows the exact positioning of the connectors in the insertion position, thus securing the needed quality for the insertion process. The dynamics of the servo drives, along with the independent wire feed system are some of the reasons for the machine's high performance. It can produce a wide range of harnesses with average cycle time of approx. 5.4 seconds, means 8000 wires/hour. The machine can perform daisy-chained harnesses along with the crimping of single terminals. Up to 12 different wires can be fed simultaneously to the insertion system using independent wire feed systems, thus not reducing the overall machine performance. Crimping presses can optionally be equipped with crimp force measuring systems, monitoring the accuracy of the individual crimp. Machine can be set up with a Bowl Feeder for Single Sleeve insertion (optional). This unit works in cycle time with the performance of the machine. A high precision mechanical device can perform the key coding for all connectors on the pallet with the related integrated test equipment. Quality check by camera system integrated in the manufacturing process (optional).



Le macchine INAR-AHM Evolution vengono prodotte in due versioni:

- INAR-AHM Evolution 25 per INAR-IDC RAST 2,5
- INAR-AHM Evolution 50 per INAR-IDC RAST 2,5 Energy, RAST 5 e RAST 5 PCB

INAR-AHM EVOLUTION 25

Configurazioni standard

e caratteristiche dei prodotti da processare:

- 6 stazioni di alimentazione e inserimento filo lato testa, 3 di inserimento filo lato coda.
- Processa connettori Inarca IDC-RAST 2.5 in tutte le versioni prodotte, da 3 a 20 vie.
- Range filo 0.22 – 0.35 mm, diametro max. isolante 1.7 mm
- Lunghezza filo: min. 250 mm – max. 3000 mm.
A cavo libero da un lato lunghezza min. 80 mm
- Tipo di cavo: PVC / silicone
(i cavi devono essere omologati da Inarca)
- Stazione di polarizzazione.
- Controllo ottico a mezzo telecamere sulla qualità dell'inserimento del cavo e controllo del colore del cavo.
- Marcatura eventuali scarti.
- Stazione di aggraffatura
- Stazione inserimento capsule (optional)
- Colorazione sul coperchio del connettore in entrambe le guide di scarico.
- Numero di vie per pallet: 54 effettive
- Tempo ciclo: 5.4 secondi
- Schemi eseguibili: parallelo; incrociato; loop, aggraffato.

INAR-AHM EVOLUTION 50

Configurazioni standard

e caratteristiche dei prodotti da processare:

- 8 stazioni di alimentazione e inserimento filo lato testa, 4 di inserimento filo lato coda
- Processa connettori Inarca IDC-RAST 2,5 Energy in tutte le versioni prodotte da 2 a 12 vie, RAST 5 da 2 a 10 vie, e RAST 5 PCB da 2 a 12 vie
- Range filo 0.35 – 1.5 mm, diametro max. isolante 3.2 mm
- Lunghezza filo: min. 250 mm – max. 3000 mm.
A cavo libero da un lato lunghezza min. 80 mm
- Tipo di cavo: PVC (i cavi devono essere omologati da Inarca)
- Stazione di polarizzazione
- Controllo ottico a mezzo di telecamere sulla qualità dell'inserimento del cavo e controllo del colore del cavo

INAR-AHM Evolution are available in two version:

- AHM 25 Evolution for all the Inarca RAST 2,5 connector system
- AHM 50 Evolution for all Inarca RAST 2,5 Energy, RAST 5 and RAST 5 PCB connector system

AHM 25 EVOLUTION

Technical Features:

- 6 stations for feeding and wire termination to main side, 3 station for wire termination to end side.
- Termination of all kind of Inarca IDC RAST 2.5 connector system from 3 to 20 poles.
- Range size range wire 0.22 – 0.35 mm,
- Insulation diameter range max 1.7 mm.
- Wire length: min. 250mm – max 3000mm.
With wire free to one side min. length 80 mm.
- Wire type: Stranded Conductors PVC / silicon
(wire must to homologate from Inarca).
- Key Coding Station.
- Quality check by camera system integrated in the manufacturing process (optional).
- Marking on scrap.
- Crimping Station to produce harnesses with crimp terminal on one side
- Insertion sleeves unit (optional).
- Color Marking on the connector cover in both guides.
- 54 poles for pallet.
- Cycle time 5.4" (seconds).
- Harnesses type: parallel, cross, loop and crimped to one side.

AHM 50 EVOLUTION

Technical Features:

- 8 stations for feeding and wire termination to main side, 4 station for wire termination to end side.
- Termination of kind of Inarca IDC RAST 2.5 Energy in all version from 2 to 12 poles, RAST 5 from 2 to 10 poles, RAST 5 PCB from 2 to 12 poles.
- Wire Size Range 0.35 up to 1.5 mm,
- Insulation diameter range max. 3.2 mm.
- Wire length: min. 250 mm – max. 3000 mm.
With wire free to one side min. length 80 mm.
- Wire type: Stranded Conductors PVC / silicon
(wire must to homologate from Inarca).
- Key Coding Station.
- Quality check by camera system integrated in the manufacturing process (optional).

- Marcatura eventuali scarti
- Stazione di aggraffatura
- Stazione inserimento capsule (optional)
- Colorazione sul coperchio del connettore in entrambe le guide di scarico.
- Numero di vie per pallet: 28 effettive
- Tempo ciclo: 5.4 secondi
- Schemi eseguibili: parallelo, incrociato, loop, aggraffato.

Caratteristiche tecniche

Alimentazione elettrica: 400V +/-10% (3F+T) 50 Hz.

Alimentazione pneumatica: 6 bar.

Dimensioni: da 4,50 a 16 m di lunghezza x 4 m di larghezza.

Rumorosità: inferiore a 78 db (A).

Gestione elettronica

La macchina è gestita da un PLC di marca Siemens e corredata di un touch screen di interfaccia con l'operatore e da un PC utilizzato per la supervisione del processo della linea. Tutte le funzioni della macchina sono gestite tramite questa interfaccia. I dati relativi alla produzione eseguita, sono memorizzati dal sistema.

Caratteristiche produttive

Tempo ciclo: minimo 5,4 sec per pallet, 8 cavi caricati, lunghezza fino a 1200 mm, tempo per ogni cavo 0,675 secondi (dati relativi alla configurazione con 8 stazioni di alimentazione filo).

- Marking on scrap.
- Crimping Station to produce harnesses with crimp terminal on one side
- Insertion sleeves unit (optional).
- Color Marking on the connector cover in both guides.
- 28 poles for pallet.
- Cycle time 5.4" (seconds).
- Harnesses type: parallel, cross, loop and crimped to one side.

Technical features

Electrical feeding: 400V \pm 10% (3F+T) 50 Hz.

Pneumatic Power: 6 bar

Dimension: from 4,50 to 16 meter length x 4 meter width.

Noise: less than 78 dB.

Electronic management

The machine is managed by a PLC Siemens with a touch screen display to interact with the operator and with a computer used to manage the entire process. All the data regarding the production are stored from the system.

Productive features

Cycle time: min. 5,4 sec. each pallet; 8 wires loaded, length up to 1200 mm, time for each cable 0,675 seconds (for version with 8 insertion unit).

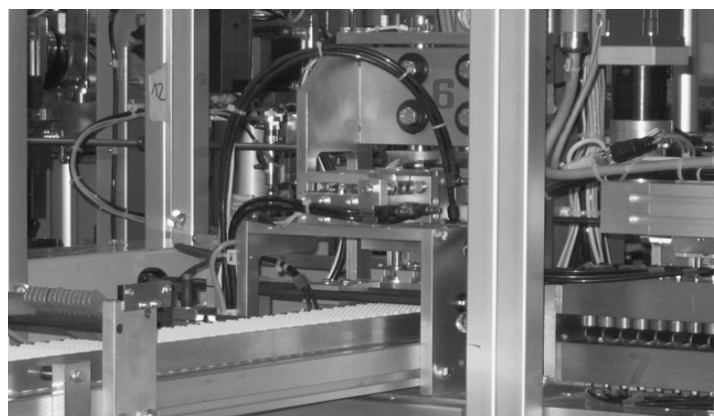
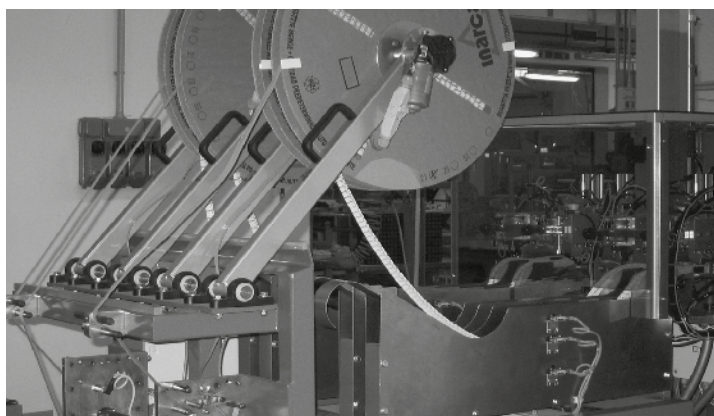
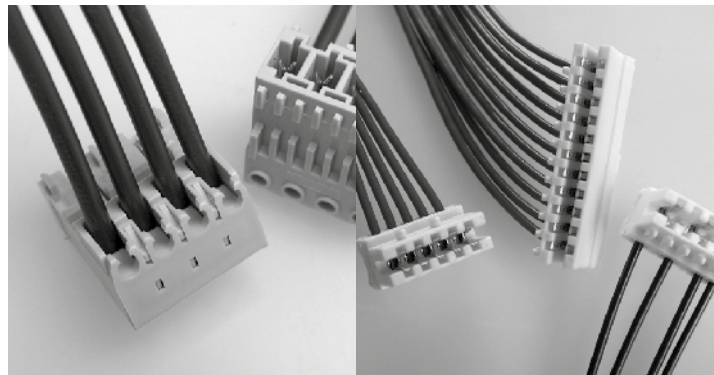

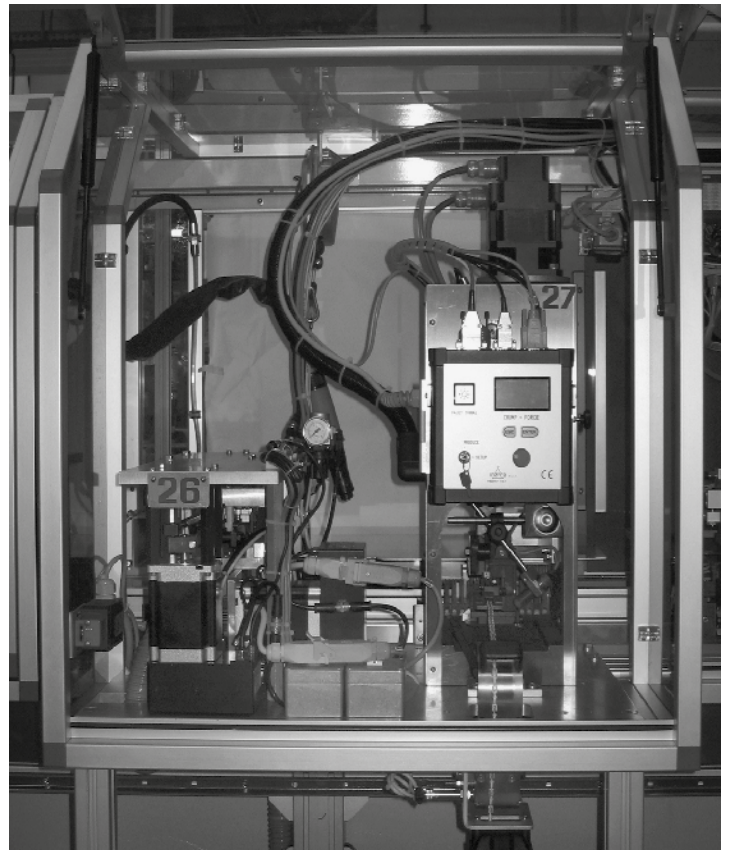
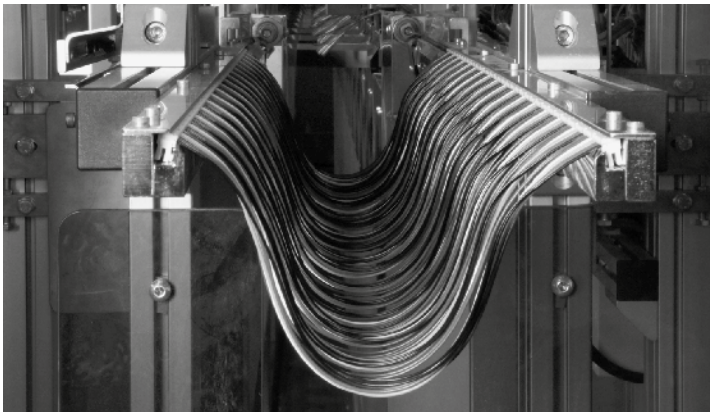
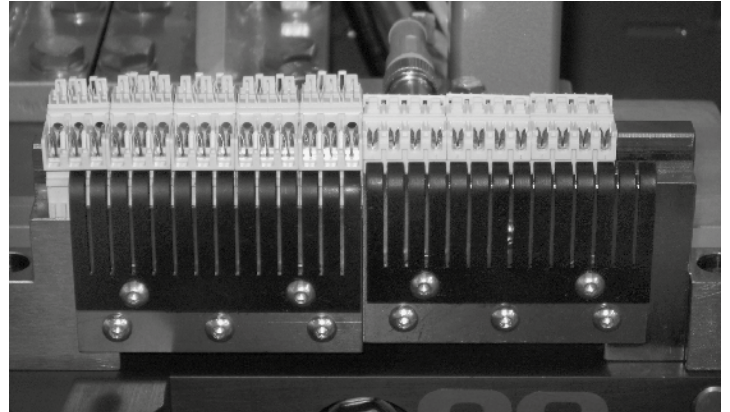
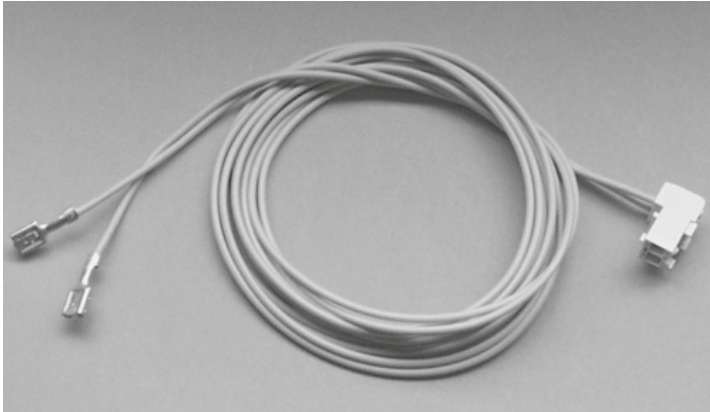
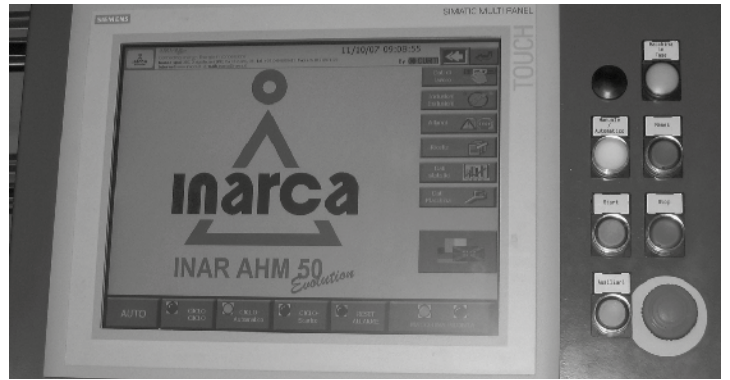
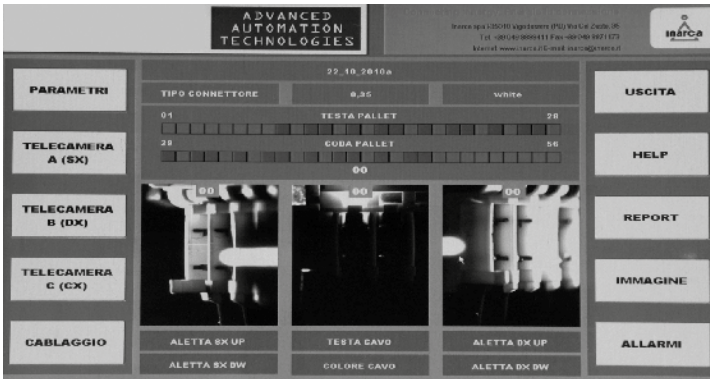

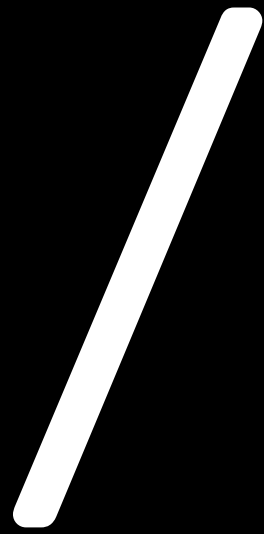

Alphanumeric index

Cod. Disegno Drawing Code	Art. N° P.N.	Pag. Pag.	Cod. Disegno Drawing Code	Art. N° P.N.	Pag. Pag.	Cod. Disegno Drawing Code	Art. N° P.N.	Pag. Pag.
PC80403_00	8540300701	106	PC80403_23	8540323701	111	PC80404_09	8540409701	106
PC80403_00	8540300706	106	PC80403_23	8540323706	111	PC80404_09	8540409706	106
PC80403_01	8540301701	106	PC80403_24	8540324701	106	PC80404_10	8540410701	106
PC80403_01	8540301706	106	PC80403_24	8540324706	106	PC80404_10	8540410706	106
PC80403_02	8540302701	106	PC80403_25	8540325701	106	PC80404_11	8540411701	117
PC80403_02	8540302706	106	PC80403_25	8540325706	106	PC80404_11	8540411706	117
PC80403_03	8540303701	106	PC80403_26	8540326701	117	PC80404_12	8540412701	117
PC80403_03	8540303706	106	PC80403_26	8540326706	117	PC80404_12	8540412706	117
PC80403_04	8540304701	106	PC80403_27	8540327701	115	PC80404_13	8540413701	117
PC80403_04	8540304706	106	PC80403_27	8540327706	115	PC80404_13	8540413706	117
PC80403_05	8540305701	117	PC80403_28	8540328701	106	PC80404_14	8540414701	117
PC80403_05	8540305706	117	PC80403_28	8540328706	106	PC80404_14	8540414706	117
PC80403_06	8540306701	106	PC80403_29	8540329701	115	PC80404_15	8540415701	111
PC80403_06	8540306706	106	PC80403_29	8540329706	115	PC80404_15	8540415706	111
PC80403_07	8540307701	106	PC80403_30	8540330701	117	PC80405_00	8540500701	106
PC80403_07	8540307706	106	PC80403_30	8540330706	117	PC80405_00	8540500706	106
PC80403_08	8540308701	106	PC80403_31	8540331701	117	PC80405_01	8540501701	106
PC80403_08	8540308706	106	PC80403_31	8540331706	117	PC80405_01	8540501706	106
PC80403_09	8540309701	106	PC80403_32	8540332701	115	PC80405_02	8540502701	111
PC80403_09	8540309706	106	PC80403_32	8540332706	115	PC80405_02	8540502706	111
PC80403_10	8540310701	106	PC80403_33	8540333706	106	PC80405_03	8540503701	117
PC80403_10	8540310706	106	PC80403_33	8540333701	111	PC80405_03	8540503706	117
PC80403_11	8540311701	106	PC80403_34	8540334701	111	PC80405_04	8540504701	111
PC80403_11	8540311706	106	PC80403_34	8540334706	111	PC80405_04	8540504706	111
PC80403_12	8540312701	117	PC80403_35	8540335701	106	PC80405_05	8540505701	111
PC80403_12	8540312706	117	PC80403_35	8540335706	106	PC80405_05	8540505706	111
PC80403_13	8540313701	106	PC80403_36	8540336701	117	PC80405_06	8540506701	106
PC80403_13	8540313706	106	PC80403_36	8540336706	117	PC80405_06	8540506706	106
PC80403_14	8540314701	106	PC80404_00	8540400701	106	PC80405_07	8540507701	111
PC80403_14	8540314706	106	PC80404_00	8540400706	106	PC80405_07	8540507706	111
PC80403_15	8540315701	111	PC80404_01	8540401701	117	PC80405_08	8540508701	106
PC80403_15	8540315706	111	PC80404_01	8540401706	117	PC80405_08	8540508706	106
PC80403_16	8540316701	111	PC80404_02	8540402701	111	PC80405_09	8540509701	106
PC80403_16	8540316706	111	PC80404_02	8540402706	111	PC80405_09	8540509706	106
PC80403_17	8540317701	106	PC80404_03	8540403701	117	PC80405_10	8540510701	115
PC80403_17	8540317706	106	PC80404_03	8540403706	117	PC80405_10	8540510706	115
PC80403_18	8540318701	106	PC80404_04	8540404701	111	PC80405_11	8540511701	115
PC80403_18	8540318706	106	PC80404_04	8540404706	111	PC80405_11	8540511706	115
PC80403_19	8540319701	115	PC80404_05	8540405701	115	PC80405_12	8540512701	115
PC80403_19	8540319706	115	PC80404_05	8540405706	115	PC80405_12	8540512706	115
PC80403_20	8540320701	111	PC80404_06	8540406701	106	PC80405_13	8540513701	115
PC80403_20	8540320706	111	PC80404_06	8540406706	106	PC80405_13	8540513706	115
PC80403_21	8540321701	115	PC80404_07	8540407701	117	PC80405_14	8540514701	111
PC80403_21	8540321706	115	PC80404_07	8540407706	117	PC80405_14	8540514706	111
PC80403_22	8540322701	111	PC80404_08	8540408701	117	PC80405_15	8540515701	117
PC80403_22	8540322706	111	PC80404_08	8540408706	117	PC80405_15	8540515706	117

Cod. Disegno Drawing Code	Art. N° P.N.	Pag. Pag.
PC80405_16	8540516701	117
PC80405_16	8540516706	117
PC80405_17	8540517701	117
PC80405_17	8540517706	117
PC80405_18	8540518701	117
PC80405_18	8540518706	117
PC80405_19	8540519701	115
PC80405_19	8540519706	115
PC80405_20	8540520701	106
PC80405_20	8540520706	106
PC80405_21	8540521701	115
PC80405_21	8540521706	115
PC80405_22	8540522701	117
PC80405_22	8540522706	117
PC80406_00	8540600701	106
PC80406_00	8540600706	106
PC80406_01	8540601701	117
PC80406_01	8540601706	117
PC80406_02	8540602701	117
PC80406_02	8540602706	117
PC80406_03	8540603701	106
PC80406_03	8540603706	106
PC80406_04	8540604701	111
PC80406_04	8540604706	111
PC80406_05	8540605701	117
PC80406_05	8540605706	117
PC80406_06	8540606701	111
PC80406_06	8540606706	111
PC80406_07	8540607701	115
PC80406_07	8540607706	115
PC80406_08	8540608701	111
PC80406_08	8540608706	111
PC80406_09	8540609701	106
PC80406_09	8540609706	106
PC80406_10	8540610701	117
PC80406_10	8540610706	117
PC80406_11	8540611701	106
PC80406_11	8540611706	106
PC80406_12	8540612701	106
PC80406_12	8540612706	106
PC80406_13	8540613701	106
PC80406_13	8540613706	106
PC80406_14	8540614701	106
PC80406_14	8540614706	106
PC80406_15	8540615701	106
PC80406_15	8540615706	106

Cod. Disegno Drawing Code	Art. N° P.N.	Pag. Pag.
PC80406_16	8540616701	106
PC80406_16	8540616706	106
PC80406_17	8540617701	106
PC80406_17	8540617706	106
PC80406_18	8540618701	111
PC80406_18	8540618706	111
PC80406_19	8540619701	106
PC80406_19	8540619706	106
PC80406_20	8540620701	106
PC80406_20	8540620706	106
PC80406_21	8540621706	111
PC80406_22	8540622701	106
PC80406_22	8540622706	106
PC80406_23	8540623701	117
PC80406_23	8540623706	117
PC80407_00	8540700701	106
PC80407_00	8540700706	106
PC80407_01	8540701701	106
PC80407_01	8540701706	106
PC80407_02	8540702701	117
PC80407_02	8540702706	117
PC80407_03	8540703701	111
PC80407_03	8540703706	111
PC80407_04	8540704701	106
PC80407_04	8540704706	106
PC80407_05	8540705701	115
PC80407_05	8540705706	115
PC80407_06	8540706701	115
PC80407_06	8540706706	115
PC80407_07	8540707701	115
PC80407_07	8540707706	115
PC80407_08	8540708701	111
PC80407_08	8540708706	111
PC80407_09	8540709701	106
PC80407_09	8540709706	106
PC80407_10	8540710701	117
PC80407_10	8540710706	117
PC80407_11	8540711701	111
PC80407_11	8540711706	111
PC80407_12	8540712701	106
PC80407_12	8540712706	106
PC80407_13	8540713701	117
PC80407_13	8540713706	117
PC80407_14	8540714701	111
PC80407_14	8540714706	111
PC80407_15	8540715701	117

Cod. Disegno Drawing Code	Art. N° P.N.	Pag. Pag.
PC80407_15	8540715706	117
PC80408_00	8540800701	106
PC80408_00	8540800706	106
PC80408_01	8540801701	117
PC80408_01	8540801706	117
PC80408_02	8540802701	106
PC80408_02	8540802706	106
PC80408_03	8540803701	111
PC80408_03	8540803706	111
PC80408_04	8540804701	111
PC80408_04	8540804706	111
PC80408_05	8540805701	111
PC80408_05	8540805706	111
PC80408_06	8540806701	106
PC80408_06	8540806706	106
PC80408_07	8540807701	111
PC80408_07	8540807706	111
PC80408_08	8540808701	106
PC80408_08	8540808706	106
PC80409_00	8540900701	106
PC80409_00	8540900706	106
PC80409_01	8540901701	106
PC80409_01	8540901706	106
PC80409_02	8540902701	111
PC80409_02	8540902706	111
PC80409_03	8540903701	111
PC80409_03	8540903706	111
PC80409_04	8540904701	106
PC80409_04	8540904706	106
PC80409_05	8540905701	117
PC80409_05	8540905706	117
PC80409_06	8540906701	111
PC80409_06	8540906706	111
PC80409_07	8540907701	111
PC80409_07	8540907706	111
PC80409_08	8540908701	111
PC80409_08	8540908706	111
PC80409_09	8540909701	111
PC80409_09	8540909706	111
PC80409_10	8540910701	111
PC80409_10	8540910706	111
PC80409_11	8540911701	106
PC80409_11	8540911706	106
PC80409_12	8540912701	117
PC80409_12	8540912706	117
PC80409_13	8540913701	117

Cod. Disegno Drawing Code	Art. N° P.N.	Pag. Pag.	Cod. Disegno Drawing Code	Art. N° P.N.	Pag. Pag.	Cod. Disegno Drawing Code	Art. N° P.N.	Pag. Pag.
PC80409_13	8540913706	117	PC80413_02	8541302706	106	PC80503_13	8550313706A	136
PC80410_00	8541000701	106	PC80413_03	8541303701	111	PC80504_00	8550400706A	136
PC80410_00	8541000706	106	PC80413_03	8541303706	111	PC80504_02	8550402796A	136
PC80410_01	8541001701	117	PC80414_00	8541400701	106	PC80504_03	8550403706A	136
PC80410_01	8541001706	117	PC80414_00	8541400706	106	PC80504_05	8550405796A	136
PC80410_02	8541002701	117	PC80414_01	8541401701	115	PC80504_06	8550406706A	136
PC80410_02	8541002706	117	PC80414_01	8541401706	115	PC80504_08	8550408796A	136
PC80410_03	8541003701	106	PC80414_02	8541402701	117	PC80504_10	8550410796A	136
PC80410_03	8541003706	106	PC80414_02	8541402706	117	PC80505_00	8550500706A	136
PC80410_04	8541004701	106	PC80414_03	8541403701	117	PC80505_02	8550502706A	136
PC80410_04	8541004706	106	PC80414_03	8541403706	117	PC80505_03	8550503706A	136
PC80410_05	8541005701	115	PC80415_00	8541500701	106	PC80505_04	8550504706A	136
PC80410_05	8541005706	115	PC80415_00	8541500706	106	PC80505_06	8550506706A	136
PC80410_06	8541006701	117	PC80415_01	8541501701	106	PC80505_08	8550508706A	136
PC80410_06	8541006706	117	PC80415_01	8541501706	106	PC80505_10	8550510796A	136
PC80410_07	8541007701	111	PC80415_02	8541502701	115	PC80505_11	8550511706A	136
PC80410_07	8541007706	111	PC80415_02	8541502706	115	PC80505_12	8550512706A	136
PC80411_00	8541100701	106	PC80416_00	8541600701	106	PC80505_13	8550513706A	136
PC80411_00	8541100706	106	PC80416_00	8541600706	106	PC80505_14	8550514706A	136
PC80411_01	8541101701	106	PC80416_01	8541601701	117	PC80506_00	8550600706A	136
PC80411_01	8541101706	106	PC80416_01	8541601706	117	PC80506_02	8550602706A	136
PC80411_02	8541102701	106	PC80417_00	8541700701	106	PC80506_04	8550604706A	136
PC80411_02	8541102706	106	PC80417_00	8541700706	106	PC80506_06	8550606706A	136
PC80411_03	8541103701	111	PC80417_01	8541701701	106	PC80506_08	8550608706A	136
PC80411_03	8541103706	111	PC80417_01	8541701706	106	PC80506_10	8550610706A	136
PC80411_04	8541104701	111	PC80418_00	8541800701	106	PC80506_11	8550611706A	136
PC80411_04	8541104706	111	PC80418_00	8541800706	106	PC80506_12	8550612706A	136
PC80412_00	8541200701	106	PC80419_00	8541900701	106	PC80506_13	8550613706A	136
PC80412_00	8541200706	106	PC80419_00	8541900706	106	PC80507_00	8550700706A	136
PC80412_01	8541201701	111	PC80419_01	8541901701	106	PC80507_05	8550705706A	136
PC80412_01	8541201706	111	PC80419_01	8541901706	106	PC80507_06	8550706706A	136
PC80412_02	8541202701	117	PC80420_00	8542000701	106	PC80507_07	8550707706A	136
PC80412_02	8541202706	117	PC80420_00	8542000706	106	PC80507_08	8550708706A	136
PC80412_03	8541203701	111	PC80502_00	8550200706A	136	PC80507_09	8550709706A	136
PC80412_03	8541203706	111	PC80502_02	8550202796A	136	PC80507_10	8550710706A	136
PC80412_04	8541204701	111	PC80502_03	8550203706A	136	PC80507_11	8550711706A	136
PC80412_04	8541204706	111	PC80502_05	8550205796A	136	PC80508_00	8550800706A	136
PC80412_05	8541205701	106	PC80503_00	8550300706A	136	PC80508_02	8550802706A	136
PC80412_05	8541205706	106	PC80503_02	8550302796A	136	PC80508_04	8550804706A	136
PC80412_06	8541206701	111	PC80503_03	8550303706A	136	PC80508_05	8550805706A	136
PC80412_06	8541206706	111	PC80503_05	8550305796A	136	PC80508_06	8550806706A	136
PC80413_00	8541300701	106	PC80503_07	8550307706A	136	PC80508_07	8550807706A	136
PC80413_00	8541300706	106	PC80503_07	8550308796A	136	PC80509_00	8550900706A	136
PC80413_01	8541301701	106	PC80503_08	8550308796A	136	PC80509_02	8550902706A	136
PC80413_01	8541301706	106	PC80503_09	8550309706A	136	PC80509_04	8550904706A	136
PC80413_02	8541302701	106	PC80503_11	8550311796A	136	PC80509_06	8550906706A	136

Cod. Disegno Drawing Code	Art. N° P.N.	Pag. Pag.	Cod. Disegno Drawing Code	Art. N° P.N.	Pag. Pag.	Cod. Disegno Drawing Code	Art. N° P.N.	Pag. Pag.
PC80510_00	8551000706A	136	PC80604_17	8560417701	125	PC80607_13	8560713701	125
PC80510_03	8551003706A	136	PC80604_18	8560418701	125	PC80607_14	8560714701	125
PC80510_04	8551004706A	136	PC80604_19	8560419701	125	PC80607_15	8560715701	122
PC80602_00	8560200701	122	PC80604_20	8560420701	125	PC80608_00	8560800701	122
PC80602_01	8560201701	122	PC80604_21	8560421701	125	PC80608_01	8560801701	122
PC80602_02	8560202701	122	PC80604_22	8560422701	125	PC80608_02	8560802701	122
PC80602_03	8560203701	125	PC80605_00	8560500701	122	PC80608_03	8560803701	125
PC80602_04	8560204701	125	PC80605_01	8560501701	122	PC80608_04	8560804701	125
PC80602_05	8560205701	125	PC80605_02	8560502701	122	PC80608_05	8560805701	125
PC80602_06	8560206701	125	PC80605_03	8560503701	125	PC80608_06	8560806701	125
PC80602_07	8560207701	125	PC80605_04	8560504701	125	PC80608_07	8560807701	125
PC80602_08	8560208701	125	PC80605_05	8560505701	125	PC80608_08	8560808701	125
PC80602_09	8560209701	125	PC80605_06	8560506701	125	PC80608_09	8560809701	125
PC80602_10	8560210701	122	PC80605_07	8560507701	125	PC80608_10	8560810701	125
PC80603_00	8560300701	122	PC80605_08	8560508701	125	PC80608_11	8560811701	125
PC80603_01	8560301701	122	PC80605_09	8560509701	125	PC80609_00	8560900701	122
PC80603_02	8560302701	122	PC80605_10	8560510701	125	PC80609_01	8560901701	122
PC80603_03	8560303701	125	PC80605_11	8560511701	125	PC80609_02	8560902701	122
PC80603_04	8560304701	125	PC80605_12	8560512701	125	PC80609_03	8560903701	125
PC80603_05	8560305701	125	PC80605_13	8560513701	125	PC80609_04	8560904701	125
PC80603_06	8560306701	125	PC80605_14	8560514701	125	PC80609_05	8560905701	125
PC80603_07	8560307701	125	PC80606_00	8560600701	122	PC80609_06	8560906701	125
PC80603_08	8560308701	125	PC80606_01	8560601701	122	PC80609_07	8560907701	125
PC80603_09	8560309701	125	PC80606_02	8560602701	122	PC80609_08	8560908701	125
PC80603_10	8560310701	125	PC80606_03	8560603701	125	PC80609_09	8560909701	125
PC80603_11	8560311701	125	PC80606_04	8560604701	125	PC80609_10	8560910701	125
PC80603_12	8560312701	125	PC80606_05	8560605701	125	PC80609_11	8560911701	125
PC80603_13	8560313701	125	PC80606_06	8560606701	125	PC80609_12	8560912701	125
PC80603_14	8560314701	125	PC80606_07	8560607701	125	PC80609_13	8560913701	125
PC80604_00	8560400701	122	PC80606_08	8560608701	125	PC80609_14	8560914701	125
PC80604_01	8560401701	122	PC80606_09	8560609701	125	PC80609_15	8560915701	125
PC80604_02	8560402701	122	PC80606_10	8560610701	125	PC80609_16	8560916701	122
PC80604_03	8560403701	125	PC80606_11	8560611701	125	PC80609_17	8560917701	125
PC80604_04	8560404701	125	PC80606_12	8560612701	125	PC80610_00	8561000701	122
PC80604_05	8560405701	125	PC80607_00	8560700701	122	PC80610_01	8561001701	122
PC80604_06	8560406701	125	PC80607_01	8560701701	122	PC80610_02	8561002701	122
PC80604_07	8560407701	125	PC80607_02	8560702701	122	PC80610_03	8561003701	125
PC80604_08	8560408701	125	PC80607_03	8560703701	125	PC80610_04	8561004701	125
PC80604_09	8560409701	125	PC80607_04	8560704701	125	PC80610_05	8561005701	125
PC80604_10	8560410701	125	PC80607_05	8560705701	125	PC80610_06	8561006701	125
PC80604_11	8560411701	125	PC80607_06	8560706701	125	PC80610_07	8561007701	125
PC80604_12	8560412701	125	PC80607_07	8560707701	125	PC80610_08	8561008701	125
PC80604_13	8560413701	125	PC80607_09	8560709701	125	PC80610_09	8561009701	125
PC80604_14	8560414701	125	PC80607_10	8560710701	125	PC80610_10	8561010701	125
PC80604_15	8560415701	125	PC80607_11	8560711701	122	PC80610_11	8561011701	125
PC80604_16	8560416701	125	PC80607_12	8560712701	125	PC80610_12	8561012701	125

Cod. Disegno Drawing Code	Art. N° P.N.	Pag. Pag.	Cod. Disegno Drawing Code	Art. N° P.N.	Pag. Pag.	Cod. Disegno Drawing Code	Art. N° P.N.	Pag. Pag.
PC80610_13	8561013701	125	PC80804_05	8580405706	141	PC80807_14	8580714706	141
PC80611_00	8561100701	122	PC80804_06	8580406706	141	PC80808_03	8580803706	141
PC80611_01	8561101701	122	PC80804_07	8580407706	141	PC80808_04	8580804706	141
PC80611_02	8561102701	122	PC80804_08	8580408706	141	PC80808_05	8580805706	141
PC80611_03	8561103701	125	PC80804_09	8580409706	141	PC80808_06	8580806706	141
PC80611_04	8561104701	125	PC80804_10	8580410706	141	PC80808_07	8580807706	141
PC80611_05	8561105701	125	PC80804_11	8580411706	141	PC80808_08	8580808706	141
PC80611_06	8561106701	125	PC80804_12	8580412706	141	PC80808_09	8580809706	141
PC80611_07	8561107701	125	PC80804_13	8580413706	141	PC80808_10	8580810706	141
PC80611_08	8561108701	125	PC80804_14	8580414706	141	PC80808_11	8580811706	141
PC80611_09	8561109701	125	PC80804_15	8580415706	141	PC80809_03	8580903706	141
PC80611_10	8561110701	125	PC80804_16	8580416706	141	PC80809_04	8580904706	141
PC80611_11	8561111701	125	PC80804_17	8580417706	141	PC80809_05	8580905706	141
PC80612_00	8561200701	122	PC80804_18	8580418706	141	PC80809_06	8580906706	141
PC80612_01	8561201701	122	PC80804_19	8580419706	141	PC80809_07	8580907706	141
PC80612_02	8561202701	122	PC80805_03	8580503706	141	PC80809_08	8580908706	141
PC80612_03	8561203701	125	PC80805_04	8580504706	141	PC80809_09	8580909706	141
PC80612_04	8561204701	125	PC80805_05	8580505706	141	PC80809_10	8580910706	141
PC80612_05	8561205701	125	PC80805_06	8580506706	141	PC80809_11	8580911706	141
PC80612_06	8561206701	125	PC80805_07	8580507706	141	PC80809_12	8580912706	141
PC80612_07	8561207701	125	PC80805_08	8580508706	141	PC80809_13	8580913706	141
PC80612_08	8561208701	125	PC80805_09	8580509706	141	PC80809_14	8580914706	141
PC80612_09	8561209701	125	PC80805_10	8580510706	141	PC80809_15	8580915706	141
PC80612_10	8561210701	125	PC80805_11	8580511706	141	PC80809_16	8580916706	141
PC80612_11	8561211701	125	PC80805_12	8580512706	141	PC80810_03	8581003706	141
PC80612_12	8561212701	125	PC80806_03	8580603706	141	PC80810_04	8581004706	141
PC80802_03	8580203706	141	PC80806_04	8580604706	141	PC80810_05	8581005706	141
PC80802_04	8580204706	141	PC80806_05	8580605706	141	PC80810_06	8581006706	141
PC80802_05	8580205706	141	PC80806_06	8580606706	141	PC80810_07	8581007706	141
PC80802_06	8580206706	141	PC80806_07	8580607706	141	PC80810_08	8581008706	141
PC80802_07	8580207706	141	PC80806_08	8580608706	141	PC80810_09	8581009706	141
PC80802_08	8580208706	141	PC80806_09	8580609706	141	PC80810_10	8581010706	141
PC80802_09	8580209706	141	PC80806_10	8580610706	141	PC80810_11	8581011706	141
PC80802_10	8580210706	141	PC80806_11	8580611706	141	PC80810_12	8581012706	141
PC80802_11	8580211706	141	PC80806_12	8580612706	141	PC80810_13	8581013706	141
PC80803_03	8580303706	141	PC80806_13	8580613706	141	PC80811_03	8581103706	141
PC80803_04	8580304706	141	PC80807_03	8580703706	141	PC80811_04	8581104706	141
PC80803_05	8580305706	141	PC80807_04	8580704706	141	PC80811_05	8581105706	141
PC80803_06	8580306706	141	PC80807_05	8580705706	141	PC80811_06	8581106706	141
PC80803_07	8580307706	141	PC80807_06	8580706706	141	PC80811_07	8581107706	141
PC80803_08	8580308706	141	PC80807_07	8580707706	141	PC80811_08	8581108706	141
PC80803_09	8580309706	141	PC80807_08	8580708706	141	PC80811_09	8581109706	141
PC80803_10	8580310706	141	PC80807_09	8580709706	141	PC80811_10	8581110706	141
PC80803_11	8580311706	141	PC80807_10	8580710706	141	PC80811_11	8581111706	141
PC80804_03	8580403706	141	PC80807_12	8580712706	141	PC80812_03	8581203706	141
PC80804_04	8580404706	141	PC80807_13	8580713706	141	PC80812_04	8581204706	141

Cod. Disegno Drawing Code	Art. N° P.N.	Pag. Pag.	Cod. Disegno Drawing Code	Art. N° P.N.	Pag. Pag.	Cod. Disegno Drawing Code	Art. N° P.N.	Pag. Pag.
PC80812_05	8581205706	141	PL11213	0011213301	063	PL11364	0111364101	078
PC80812_06	8581206706	141	PL11213	0111213101	063	PL11364	0911364001	078
PC80812_07	8581207706	141	PL11213	0111213301	063	PL11365	0011365001	078
PC80812_08	8581208706	141	PL11213	1411213101	063	PL11365	0011365101	078
PC80812_09	8581209706	141	PL11216	0011216001	049	PL11365	0011365201	078
PC80812_10	8581210706	141	PL11216	0011216201	049	PL11365	0111365001	078
PC80812_12	8581212706	141	PL11216	0111216001	049	PL11365	0111365101	078
PL10375	0010375001	050	PL11216	0111216201	049	PL11365	0911365001	078
PL10375	0010375201	050	PL11322	0011322001	079	PL11472	0011472001	087
PL10375	0110375001	050	PL11322	0011322201	079	PL11472	0011472201	087
PL10375	0110375201	050	PL11322	0011322301	079	PL11472	0011472301	087
PL10689	0010689001	048	PL11322	0211322121	079	PL11472	0911472001	087
PL10689	0010689201	048	PL11322	0911322001	079	PL11473	0011473001	087
PL10689	0110689001	048	PL11334	0011334101	064	PL11473	0011473201	087
PL10689	0110689201	048	PL11334	0011334301	064	PL11473	0011473301	087
PL10846	0010846001	048	PL11334	0111334101	064	PL11473	0911473001	087
PL10846	0010846201	048	PL11334	0111334301	064	PL11496	0011496001	078
PL10846	0110846001	048	PL11334	0911334001	064	PL11496	0011496101	078
PL10846	0110846201	048	PL11334	1011334101	064	PL11496	0011496201	078
PL10847	0010847001	050	PL11334	1011334301	064	PL11496	0111496001	078
PL10847	0010847201	050	PL11341	0011341101	034	PL11496	0111496101	078
PL10847	0110847001	050	PL11341	0111341101	034	PL11496	0911496001	078
PL10847	0110847201	050	PL11348	0011348001	079	PL11500	0011500101	064
PL10980	0010980001	048	PL11348	0011348201	079	PL11500	0111500101	064
PL10980	0010980201	048	PL11348	0011348301	079	PL11500	1411500101	064
PL10980	0110980001	048	PL11348	0211348121	079	PL11501	0011501101	064
PL10980	0110980201	048	PL11348	0911348001	079	PL11501	0111501101	064
PL10981	0010981001	050	PL11349	0011349001	079	PL11501	1411501101	064
PL10981	0010981201	050	PL11349	0011349201	079	PL11502	0011502101	064
PL10981	0110981001	050	PL11349	0011349301	079	PL11502	0111502101	064
PL10981	0110981201	050	PL11349	0211349121	079	PL11502	1411502101	064
PL10987	0010987001	050	PL11349	0911349001	079	PL11546	0011546001	048
PL10987	0010987201	050	PL11351	0011351001	086	PL11546	0011546201	048
PL10987	0110987001	050	PL11351	0011351201	086	PL11546	0111546001	048
PL10987	0110987201	050	PL11351	0011351301	086	PL11546	0111546201	048
PL11019	0011019001	048	PL11351	0211351127	086	PL11547	0011547001	050
PL11019	0011019201	048	PL11351	0911351001	086	PL11547	0011547201	050
PL11019	0111019001	048	PL11352	0011352001	086	PL11547	0111547001	050
PL11019	0111019201	048	PL11352	0011352201	086	PL11547	0111547201	050
PL11116	0011116101	063	PL11352	0011352301	086	PL11554	0011554001	048
PL11116	0011116301	063	PL11352	0211352127	086	PL11554	0011554201	048
PL11116	0111116101	063	PL11352	0911352001	086	PL11554	0111554001	048
PL11116	0111116301	063	PL11364	0011364001	078	PL11554	0111554201	048
PL11141	0011141101	034	PL11364	0011364101	078	PL11574	0011574001	050
PL11141	0111141101	034	PL11364	0011364201	078	PL11574	0011574201	050
PL11213	0011213101	063	PL11364	0111364001	078	PL11574	0111574001	050

Cod. Disegno Drawing Code	Art. N° P.N.	Pag. Pag.	Cod. Disegno Drawing Code	Art. N° P.N.	Pag. Pag.	Cod. Disegno Drawing Code	Art. N° P.N.	Pag. Pag.
PL11574	0111574201	050	PP50085	0855085700	035	PP50106	0864106700	037
PL11575	0011575001	048	PP50085	0864085700	035	PP50107	0854107700	038
PL11575	0011575201	048	PP50086	0854086700	053	PP50107	0855107700	038
PL11575	0111575001	048	PP50086	0855086700	053	PP50107	0864107700	038
PL11575	0111575201	048	PP50086	0864086700	053	PP50108	0854108700	038
PL11576	0011576001	050	PP50088	0854088700	053	PP50108	0855108700	038
PL11576	0011576201	050	PP50088	0855088700	053	PP50108	0864108700	038
PL11576	0111576001	050	PP50088	0864088700	053	PP50109	0854109700	038
PL11576	0111576201	050	PP50089	0854089700	053	PP50109	0855109700	038
PL11577	0011577001	048	PP50089	0855089700	053	PP50109	0864109700	038
PL11577	0011577201	048	PP50089	0864089700	053	PP50110	0854110700	038
PL11577	0111577001	048	PP50091	0854091700	035	PP50110	0855110700	038
PL11577	0111577201	048	PP50091	0855091700	035	PP50110	0864110700	038
PL11578	0011578001	050	PP50091	0864091700	035	PP50111	0854111700	038
PL11578	0011578201	050	PP50092	0854092700	035	PP50111	0855111700	038
PL11578	0111578001	050	PP50092	0855092700	035	PP50111	0864111700	038
PL11578	0111578201	050	PP50092	0864092700	035	PP50112	0854112700	038
PL11579	0011579001	048	PP50093	0854093700	035	PP50112	0855112700	038
PL11579	0011579201	048	PP50093	0855093700	035	PP50112	0864112700	038
PL11579	0111579001	048	PP50093	0864093700	035	PP50113	0854113700	038
PL11579	0111579201	048	PP50094	0854094700	035	PP50113	0855113700	038
PL11580	0011580001	050	PP50094	0855094700	035	PP50113	0864113700	038
PL11580	0011580201	050	PP50094	0864094700	035	PP50134	0854134700	066
PL11580	0111580001	050	PP50095	0854095700	035	PP50134	0855134700	066
PL11580	0111580201	050	PP50095	0855095700	035	PP50134	0864134700	066
PL11581	0011581001	048	PP50095	0864095700	035	PP50135	0854135700	053
PL11581	0011581201	048	PP50096	0854096700	035	PP50135	0855135700	053
PL11581	0111581001	048	PP50096	0855096700	035	PP50135	0864135700	053
PL11581	0111581201	048	PP50096	0864096700	035	PP50136	0854136700	053
PL11582	0011582001	049	PP50097	0854097700	035	PP50136	0855136700	053
PL11582	0011582201	049	PP50097	0855097700	035	PP50136	0864136700	053
PL11582	0111582001	049	PP50097	0864097700	035	PP50137	0854137700	055
PL11582	0111582201	049	PP50098	0854098700	035	PP50137	0855137700	055
PL11602	0011602001	079	PP50098	0855098700	035	PP50137	0864137700	055
PL11602	0011602201	079	PP50098	0864098700	035	PP50142	0854142700	053
PL11602	0011602301	079	PP50099	0854099700	035	PP50142	0855142700	053
PL11602	0211602121	079	PP50099	0855099700	035	PP50142	0864142700	053
PL11602	0911602001	079	PP50099	0864099700	035	PP50152	0854152700	037
PL11636	0011636001	079	PP50104	0854104700	038	PP50152	0855152700	037
PL11636	0011636201	079	PP50104	0855104700	038	PP50152	0864152700	037
PL11636	0011636301	079	PP50104	0864104700	038	PP50153	0854153700	037
PL11636	0911636001	079	PP50105	0854105700	037	PP50153	0855153700	037
PP50049	0854049700	066	PP50105	0855105700	037	PP50153	0864153700	037
PP50049	0855049700	066	PP50105	0864105700	037	PP50156	0854156700	037
PP50049	0864049700	066	PP50106	0854106700	037	PP50156	0855156700	037
PP50085	0854085700	035	PP50106	0855106700	037	PP50156	0864156700	037

Cod. Disegno Drawing Code	Art. N° P.N.	Pag. Pag.	Cod. Disegno Drawing Code	Art. N° P.N.	Pag. Pag.	Cod. Disegno Drawing Code	Art. N° P.N.	Pag. Pag.
PP50157	0854157700	037	PP50180	0855180700	066	PP50264	0864264700	066
PP50157	0855157700	037	PP50180	0864180700	066	PP50265	0854265700	066
PP50157	0864157700	037	PP50189	0854189700	066	PP50265	0855265700	066
PP50158	0854158700	037	PP50189	0855189700	066	PP50265	0864265700	066
PP50158	0855158700	037	PP50189	0864189700	066	PP50266	0854266700	051
PP50158	0864158700	037	PP50195	0854195700	070	PP50266	0855266700	051
PP50159	0854159700	037	PP50195	0855195700	070	PP50266	0864266700	051
PP50159	0855159700	037	PP50195	0864195700	070	PP50267	0854267700	053
PP50159	0864159700	037	PP50210	0854210700	070	PP50267	0855267700	053
PP50160	0854160700	037	PP50210	0855210700	070	PP50267	0864267700	053
PP50160	0855160700	037	PP50210	0864210700	070	PP50279	0854279700	066
PP50160	0864160700	037	PP50226	0854226700	066	PP50279	0855279700	066
PP50161	0854161700	037	PP50226	0855226700	066	PP50279	0864279700	066
PP50161	0855161700	037	PP50226	0864226700	066	PP50280	0854280700	071
PP50161	0864161700	037	PP50227	0854227700	072	PP50280	0855280700	071
PP50164	0854164700	038	PP50227	0855227700	072	PP50280	0864280700	071
PP50164	0855164700	038	PP50227	0864227700	072	PP50284	0854284700	066
PP50164	0864164700	038	PP50243	0854243700	066	PP50284	0855284700	066
PP50170	0854170700	072	PP50243	0855243700	066	PP50284	0864284700	066
PP50170	0855170700	072	PP50243	0864243700	066	PP50285	0854285700	035
PP50170	0864170700	072	PP50254	0854254700	066	PP50285	0855285700	035
PP50171	0854171700	066	PP50254	0855254700	066	PP50285	0864285700	035
PP50171	0855171700	066	PP50254	0864254700	066	PP50290	0854290700	066
PP50171	0864171700	066	PP50257	0854257700	071	PP50290	0855290700	066
PP50172	0854172700	065	PP50257	0855257700	071	PP50290	0864290700	066
PP50172	0855172700	065	PP50257	0864257700	071	PP50292	0854292700	070
PP50172	0864172700	065	PP50258	0854258700	066	PP50292	0855292700	070
PP50173	0854173700	066	PP50258	0855258700	066	PP50292	0864292700	070
PP50173	0855173700	066	PP50258	0864258700	066	PP50293	0854293700	053
PP50173	0864173700	066	PP50259	0854259700	066	PP50293	0855293700	053
PP50174	0854174700	065	PP50259	0855259700	066	PP50293	0863293700	053
PP50174	0855174700	065	PP50259	0864259700	066	PP50293	0864293700	053
PP50174	0864174700	065	PP50260	0854260700	066	PP50295	0854295700	053
PP50175	0854175700	065	PP50260	0855260700	066	PP50295	0855295700	053
PP50175	0855175700	065	PP50260	0864260700	066	PP50295	0864295700	053
PP50175	0864175700	065	PP50261	0854261700	066	PP50296	0854296700	052
PP50176	0854176700	066	PP50261	0855261700	066	PP50296	0855296700	052
PP50176	0855176700	066	PP50261	0864261700	066	PP50296	0864296700	052
PP50176	0864176700	066	PP50262	0854262700	066	PP50297	0854297700	066
PP50177	0854177700	066	PP50262	0855262700	066	PP50297	0855297700	066
PP50177	0855177700	066	PP50262	0864262700	066	PP50297	0864297700	066
PP50177	0864177700	066	PP50263	0854263700	066	PP50298	0854298700	035
PP50178	0854178700	066	PP50263	0855263700	066	PP50298	0855298700	035
PP50178	0855178700	066	PP50263	0864263700	066	PP50298	0864298700	035
PP50178	0864178700	066	PP50264	0854264700	066	PP50299	0854299700	035
PP50180	0854180700	066	PP50264	0855264700	066	PP50299	0855299700	035

Cod. Disegno Drawing Code	Art. N° P.N.	Pag. Pag.	Cod. Disegno Drawing Code	Art. N° P.N.	Pag. Pag.	Cod. Disegno Drawing Code	Art. N° P.N.	Pag. Pag.
PP50299	0864299700	035	PP50328	0854328700	080	PP50359	5450359700	052
PP50300	0854300700	035	PP50328	0855328700	080	PP50359	5550359700	052
PP50300	0855300700	035	PP50328	0863328700	080	PP50359	6450359700	052
PP50300	0864300700	035	PP50329	0854329700	080	PP50362	5450362700	066
PP50301	0854301700	035	PP50329	0855329700	080	PP50362	5550362700	066
PP50301	0855301700	035	PP50329	0864329700	080	PP50362	6450362700	066
PP50301	0864301700	035	PP50338	0854338700	035	PP50363	5450363700	066
PP50306	0854306700	073	PP50338	0855338700	035	PP50363	5550363700	066
PP50306	0855306700	073	PP50338	0864338700	035	PP50363	6450363700	066
PP50306	0864306700	073	PP50340	0854340700	080	PP50366	5450366700	088
PP50312	0854312700	066	PP50340	0855340700	080	PP50366	5550366700	088
PP50312	0855312700	066	PP50340	0863340700	080	PP50366	6450366700	088
PP50312	0864312700	066	PP50342	5450342700	053	PP50371	5450371700	057
PP50314	0854314700	080	PP50342	5550342700	053	PP50371	5550371700	057
PP50314	0855314700	080	PP50342	6350342700	053	PP50371	6450371700	057
PP50314	0863314700	080	PP50342	6450342700	053	PP50381	5450381700	073
PP50315	0854315700	080	PP50344	5450344700	088	PP50381	5550381700	073
PP50315	0855315700	080	PP50344	5550344700	088	PP50381	6450381700	073
PP50315	0864315700	080	PP50344	6350344700	088	PP50386	5450386700	066
PP50316	0854316700	080	PP50344	6450344700	088	PP50386	5550386700	066
PP50316	0855316700	080	PP50345	5450345700	088	PP50386	6450386700	066
PP50316	0864316700	080	PP50345	5550345700	088	PP50387	5450387700	066
PP50317	0854317700	080	PP50345	6450345700	088	PP50387	5550387700	066
PP50317	0855317700	080	PP50346	5450346700	088	PP50387	6450387700	066
PP50317	0864317700	080	PP50346	5550346700	088	PP50388	5450388700	066
PP50318	0854318700	080	PP50346	6350346700	088	PP50388	5550388700	066
PP50318	0855318700	080	PP50346	6450346700	088	PP50388	6450388700	066
PP50318	0864318700	080	PP50347	5450347700	088	PP50394	5450394700	035
PP50319	0854319700	056	PP50347	5550347700	088	PP50394	5550394700	035
PP50319	0855319700	056	PP50347	6450347700	088	PP50394	6450394700	035
PP50319	0864319700	056	PP50348	5450348700	088	PP50399	5450399700	038
PP50320	0854320700	056	PP50348	5550348700	088	PP50399	5550399700	038
PP50320	0855320700	056	PP50348	6450348700	088	PP50399	6450399700	038
PP50320	0864320700	056	PP50349	5450349700	088	PP52008	5452008700	051
PP50321	0854321700	058	PP50349	5550349700	088	PP52008	5552008700	051
PP50321	0855321700	058	PP50349	6350349700	088	PP52008	6452008700	051
PP50321	0864321700	058	PP50349	6450349700	088	PP52009	5452009700	088
PP50323	0854323700	066	PP50351	5450351700	066	PP52009	5552009700	088
PP50323	0855323700	066	PP50351	5550351700	066	PP52009	6452009700	088
PP50323	0864323700	066	PP50351	6450351700	066	PP52010	5452010700	088
PP50325	0854325700	088	PP50357	5450357700	088	PP52010	5552010700	088
PP50325	0855325700	088	PP50357	5550357700	088	PP52010	6352010700	088
PP50325	0863325700	088	PP50357	6450357700	088	PP52010	6452010700	088
PP50327	0854327700	088	PP50358	5450358700	088	PP52011	5452011700	069
PP50327	0855327700	088	PP50358	5550358700	088	PP52011	5552011700	069
PP50327	0863327700	088	PP50358	6350358700	088	PP52011	6452011700	069

Cod. Disegno Drawing Code	Art. N° P.N.	Pag. Pag.
PP52012	5452012700	069
PP52012	5552012700	069
PP52012	6452012700	069
PP52013	5452013700	069
PP52013	5552013700	069
PP52013	6452013700	069
PP52015	5452015700	066
PP52015	5552015700	066
PP52015	6452015700	066
PP52016	5452016700	088
PP52016	5552016700	088
PP52016	6352016700	088
PP52016	6452016700	088
PP52017	5452017700	088
PP52017	5552017700	088
PP52017	6352017700	088
PP52017	6452017700	088
PP52018	5452018700	088
PP52018	5552018700	088
PP52018	6352018700	088
PP52018	6452018700	088
PP52019	5452019700	088
PP52019	5552019700	088
PP52019	6452019700	088
PP52021	5452021700	066
PP52021	5552021700	066
PP52021	6452021700	066
PP52023	5452023700	035
PP52023	5552023700	035
PP52023	6452023700	035
PP52027	5452027700	054
PP52027	5552027700	054
PP52027	6452027700	054
PP52028	5452028700	054
PP52028	5552028700	054
PP52028	6452028700	054
PP52029	5452029700	080
PP52029	5552029700	080
PP52029	6452029700	080
PP52030	5452030700	080
PP52030	5552030700	080
PP52030	6452030700	080
PP52030	6452030710	080
PP52031	5452031700	080
PP52031	5552031700	080
PP52031	6452031700	080

Cod. Disegno Drawing Code	Art. N° P.N.	Pag. Pag.
PP52032	5452032700	080
PP52032	5552032700	080
PP52032	6452032700	080
PP52047	5452047700	088
PP52047	5552047700	088
PP52047	6352047700	088
PP52064	5452064700	066
PP52064	5552064700	066
PP52064	6452064700	066
PP52065	5452065700	066
PP52065	5552065700	066
PP52065	6452065700	066
PP52067	5452067700	057
PP52067	5552067700	057
PP52067	6452067700	057
PP52070	5452070700	088
PP52070	6352070700	088
PP52071	5452071700	055
PP52071	5552071700	055
PP52071	6452071700	055
PP52072	5452072700	080
PP52072	5552072700	080
PP52072	6452072700	080
PP52073	5252073700	057
PP52073	5452073700	057
PP52073	5552073700	057
PP52074	5452074700	066
PP52074	5552074700	066
PP52074	6452074700	066
PP52075	5452075700	080
PP52075	5552075700	080
PP52075	6452075700	080
PP52077	5452077700	066
PP52077	5552077700	066
PP52077	6452077700	066
PP52079	5452079700	058
PP52079	5552079700	058
PP52079	6352079700	058
PP52141	5452141700	035
PP52141	5552141700	035
PP52141	6452141700	035
PP52149	5452149700	037
PP52149	5552149700	037
PP52149	6452149700	037
PP52157	0854157700	037
PP52157	0855157700	037

Cod. Disegno Drawing Code	Art. N° P.N.	Pag. Pag.
PP52157	0864157700	037

Graphic design: Multiplo

Layout automation: X Connection

Print: LaGrafica Faggian

Printed in Italy

June 2018

Inarca Spa

I-35010 Vigodarzere PD

Via Ca' Zusto, 35

sales@inarca.it

+39.049.8888411

www.inarca.it



Inarca Spa

I-35010 Vigodarzere PD
Via Ca' Zusto, 35

sales@inarca.it
+39.049.8888411
www.inarca.it